

TPS5410 広い入力電圧範囲、1A、降圧コンバータ

1 特長

- 5.5V～36V の広い入力電圧範囲
- 最大 1A の連続 (1.2A のピーク) 出力電流
- 内蔵された 110mΩ の MOSFET スイッチにより、最大 95% の高効率を実現
- 広い出力電圧範囲: 1.5% の初期精度で最低 1.22V まで調整可能
- 内部補償により外付け部品を最小化
- 500kHz の固定スイッチング周波数により、フィルタ サイズの小型化が可能
- 入力電圧フィードフォワードにより、ラインレギュレーションと過渡応答を向上
- 過電流制限、過電圧保護、サーマルシャットダウンによりシステムを保護
- 動作時の接合部温度範囲: -40°C～125°C
- 小型の 8 ピン SOIC パッケージで供給

2 アプリケーション

- 民生用: セットトップ ボックス、DVD、LCD ディスプレイ
- 工業用および車載オーディオ用の電源
- バッテリーチャージャ、ハイパワー LED 電源
- 12V および 24V 分散型電源システム

3 概要

TPS5410 は、低抵抗のハイサイド N チャネル MOSFET を内蔵した大出力電流の PWM コンバータです。他の特長としては、過渡条件で電圧調整の精度を維持できる高性能な電圧誤差増幅器、入力電圧が 5.5V に達するまで起動を抑える低電圧ロックアウト回路、突入電流を制限するように内部的に設定されるスロースタート回路、過渡応答を改善するための電圧フィード・フォワード回路などがあります。ENA ピンにより、シャットダウン時の消費電流を 18μA (標準値) まで低減できます。また、アクティブ High イネーブル、過電流制限、過電圧保護、サーマル シャットダウンの機能も備えています。設計の複雑さを回避し、外部部品点数を減らすために、TPS5410 の帰還ループは内部的に補償されます。

TPS5410 デバイスは、使いやすくなった、8 ピンの SOIC パッケージで提供されています。TI は評価基板とソフトウェア・ツールを提供しており、短期間の開発サイクルで、高性能な電源設計が迅速に行われることを支援しています。

パッケージ情報

部品番号	パッケージ ⁽¹⁾	パッケージ サイズ ⁽²⁾
TPS5410	D (SOIC, 8)	4.9mm × 6mm

- (1) 詳細については、[セクション 10](#) を参照してください。
- (2) パッケージ サイズ (長さ × 幅) は公称値であり、該当する場合はピンも含まれます。

Simplified Schematic

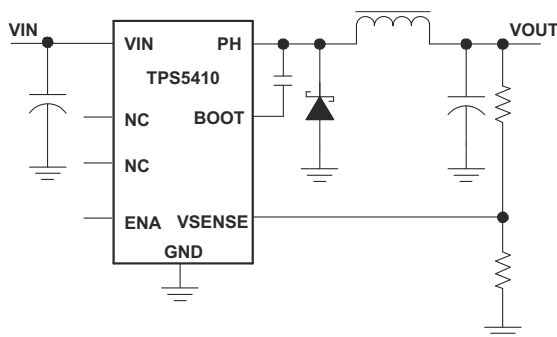

Efficiency vs Output Current

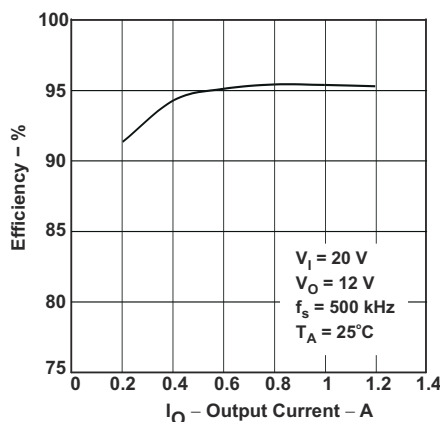

Table of Contents

1 特長	1	7 Applications and Implementation	12
2 アプリケーション	1	7.1 Application Information.....	12
3 概要	1	7.2 Typical Applications.....	12
4 Pin Configuration and Functions	3	7.3 Power Supply Recommendations.....	23
5 Specifications	3	7.4 Layout.....	23
5.1 Absolute Maximum Ratings.....	3	8 Device and Documentation Support	25
5.2 ESD Ratings.....	4	8.1 Documentation Support.....	25
5.3 Recommended Operating Conditions.....	4	8.2 ドキュメントの更新通知を受け取る方法.....	25
5.4 Thermal Information.....	4	8.3 サポート・リソース.....	25
5.5 Electrical Characteristics.....	4	8.4 Trademarks.....	25
5.6 Typical Characteristics.....	6	8.5 静電気放電に関する注意事項.....	25
6 Detailed Description	8	8.6 用語集.....	25
6.1 Overview.....	8	9 Revision History	25
6.2 Functional Block Diagram.....	9	10 Mechanical, Packaging, and Orderable Information	26
6.3 Feature Description.....	9		
6.4 Device Functional Modes.....	11		

4 Pin Configuration and Functions



図 4-1. D Package, 8 Pin SOIC Top View

表 4-1. Pin Functions

PIN		I/O	DESCRIPTION
NAME	NO.		
BOOT	1	O	Boost capacitor for the high-side FET gate driver. Connect 0.01 μ F low ESR capacitor from BOOT pin to PH pin.
NC	2, 3	—	Not connected internally.
VSENSE	4	I	Feedback voltage for the regulator. Connect to output voltage divider.
ENA	5	I	On and off control. Below 0.5 V, the device stops switching. Float the pin to enable.
GND	6	—	Ground.
VIN	7	I	Input supply voltage. Bypass VIN pin to GND pin close to device package with a high quality, low ESR ceramic capacitor.
PH	8	O	Source of the high side power MOSFET. Connected to external inductor and diode.

5 Specifications

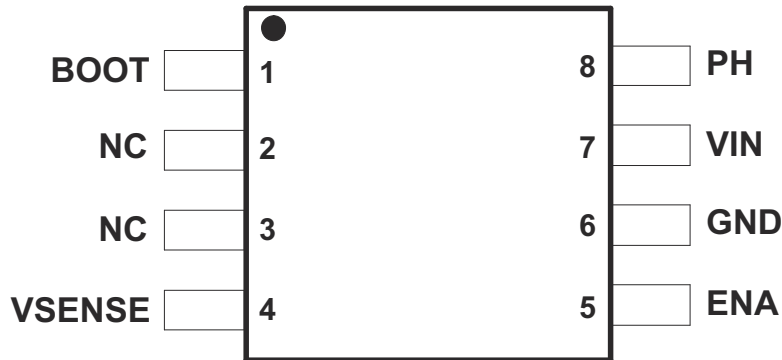
5.1 Absolute Maximum Ratings

Over operating junction temperature range (unless otherwise noted) ⁽¹⁾

		MIN	MAX	UNIT
Input voltage	VIN ⁽²⁾ to GND	-0.3	40	V
Input voltage	ENA to GND	-0.3	7	V
Input voltage	VSENSE to GND	-0.3	3	V
Output voltage	BOOT to PH	-0.3	6	V
Output voltage	PH to GND, (Steady-state) ⁽²⁾	-0.6	40	V
Output voltage	PH to GND, (transient < 10ns)	-1.2		V
Source current	PH	Internally Limited		
Source current	PH Leakage current		10	μ A
T _J	Operating virtual junction temperature	-40	150	°C
T _{stg}	Storage temperature	-65	150	°C

- (1) Operation outside the Absolute Maximum Ratings may cause permanent device damage. Absolute Maximum Ratings do not imply functional operation of the device at these or any other conditions beyond those listed under Recommended Operating Conditions. If used outside the [Recommended Operating Conditions](#) but within the Absolute Maximum Ratings, the device may not be fully functional, and this may affect device reliability, functionality, performance, and shorten the device lifetime.
- (2) Approaching the absolute maximum rating for the VIN pin may cause the voltage on the PH pin to exceed the absolute maximum rating.

5.2 ESD Ratings

			VALUE	UNIT
V _(ESD)	Electrostatic discharge	Human-body model (HBM), per ANSI/ESDA/JEDEC JS-001 ⁽¹⁾	±2000	V
		Charged-device model (CDM), per JEDEC specification JESD22-C101 ⁽²⁾	±750	

- (1) JEDEC document JEP155 states that 500-V HBM allows safe manufacturing with a standard ESD control process.
(2) JEDEC document JEP157 states that 250-V CDM allows safe manufacturing with a standard ESD control process.

5.3 Recommended Operating Conditions

Over operating junction temperature range (unless otherwise noted)

		MIN	NOM	MAX	UNIT
Input voltage	Input voltage range	5.5		36	V
T _J	Operating junction temperature	-40		125	°C

5.4 Thermal Information

THERMAL METRIC ⁽¹⁾		TPS5410			UNIT
		D (SOIC)			
		8 PINS			
R _{θJA}	Junction-to-ambient thermal resistance (Custom Board) ⁽²⁾	75			°C/W
R _{θJA}	Junction-to-ambient thermal resistance (JESD 51-7)	106			°C/W
R _{θJC(top)}	Junction-to-case (top) thermal resistance	54			°C/W
R _{θJB}	Junction-to-board thermal resistance	55			°C/W
ψ _{JT}	Junction-to-top characterization parameter	15			°C/W
ψ _{JB}	Junction-to-board characterization parameter	56			°C/W
R _{θJC(bot)}	Junction-to-case (bottom) thermal resistance	N/A			°C/W

- (1) For more information about traditional and new thermal metrics, see the [Semiconductor and IC Package Thermal Metrics](#)
(2) Refer to the TPS5420's [EVM User's Guide](#) for board layout and additional information. For thermal design information please see the Maximum Ambient Temperature section.

5.5 Electrical Characteristics

T_J = -40°C to +125°C, V_{IN} = 5.5 V to 36 V. Typical values are at T_J = 25°C and V_{IN} = 12 V (unless otherwise noted)

PARAMETER		TEST CONDITIONS	MIN	TYP	MAX	UNIT
SUPPLY VOLTAGE (VIN PIN)						
I _{Q(VIN)}	VIN quiescent current	Non-switching, V _{SENSE} = 2 V, PH pin open		2	4.4	mA
I _{SD(VIN)}	VIN shutdown supply current	Shutdown, ENA = 0 V		15	50	μA
UVLO						
V _{INUVLO(R)}	VIN UVLO rising threshold	V _{VIN} rising		5.3	5.5	V
V _{INUVLO(H)}	VIN UVLO hysteresis			0.35		V
VOLTAGE REFERENCE						
V _{FB}	FB voltage	T _J = 25°C	1.202	1.221	1.239	V
V _{FB}	FB voltage	T _J = -40°C to 125°C	1.196	1.221	1.245	V
OSCILLATOR						
f _{SW}	Switching frequency		400	500	600	kHz
t _{ON(min)}	Minimum ON pulse width			150	200	ns
D _{MAX}	Maximum Duty Cycle	f _{SW} = 500kHz	85%	89%		
ENABLE (ENA PIN)						
V _{EN(R)}	ENA voltage rising threshold				1.3	V

5.5 Electrical Characteristics (続き)

$T_J = -40^{\circ}\text{C}$ to $+125^{\circ}\text{C}$, $V_{IN} = 5.5\text{ V}$ to 36 V . Typical values are at $T_J = 25^{\circ}\text{C}$ and $V_{IN} = 12\text{ V}$ (unless otherwise noted)

PARAMETER		TEST CONDITIONS	MIN	TYP	MAX	UNIT
$V_{EN(F)}$	ENA voltage falling threshold		0.5			V
$V_{EN(H)}$	ENA voltage hysteresis			325		mV
t_{SS}	Internal slow-start time (0~100%)		6.6	8	10	ms
OVERCURRENT PROTECTION						
$I_{HS(OC)}$	High-side peak current limit		1.2	1.55	1.9	A
	Hiccup time before re-start		13	16	20	ms
OUTPUT MOSFET						
$R_{DSON(HS)}$	High-side MOSFET on-resistance	$V_{IN} = 12\text{ V}$, $V_{BOOT-SW} = 4.5\text{ V}$		100	230	m Ω
$R_{DSON(HS)}$	High-side MOSFET on-resistance	$V_{IN} = 5.5\text{ V}$, $V_{BOOT-SW} = 4.0\text{ V}$		125		m Ω
THERMAL SHUTDOWN						
$T_{J(SD)}$	Thermal shutdown threshold ⁽¹⁾	Temperature rising	135	162		$^{\circ}\text{C}$
$T_{J(HYS)}$	Thermal shutdown hysteresis ⁽¹⁾			14		$^{\circ}\text{C}$

(1) Parameter specified by design, statistical analysis and production testing of correlated parameters. Not production tested.

5.6 Typical Characteristics



图 5-1. Oscillator Frequency vs Junction Temperature



图 5-2. Operating Quiescent Current vs Junction Temperature

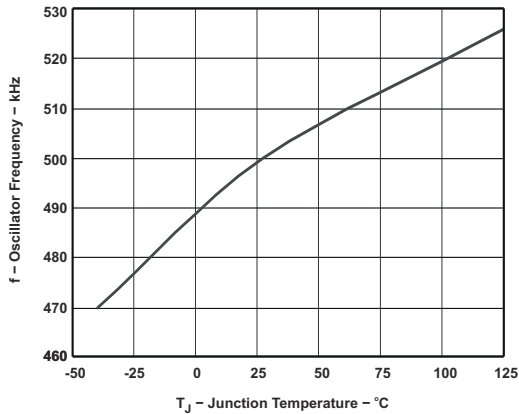

图 5-3. Minimum Controllable On Time vs Junction Temperature

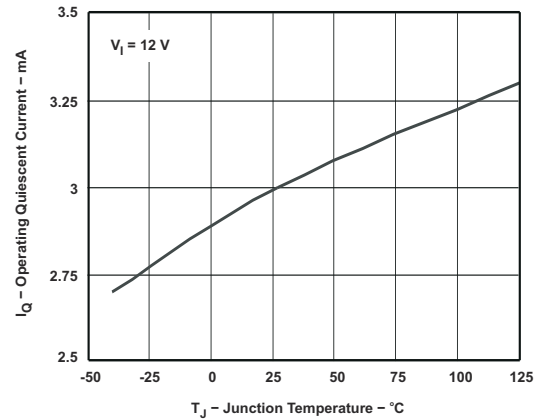

图 5-4. Voltage Reference vs Junction Temperature

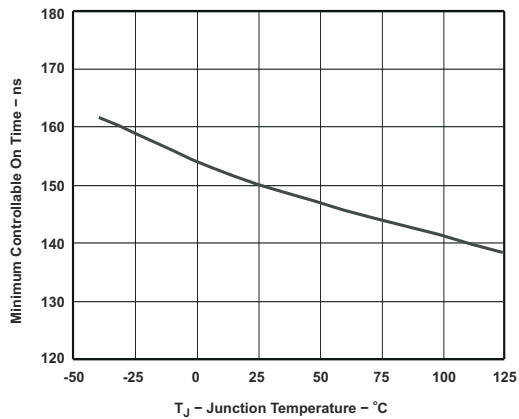

图 5-5. On State Resistance vs Junction Temperature

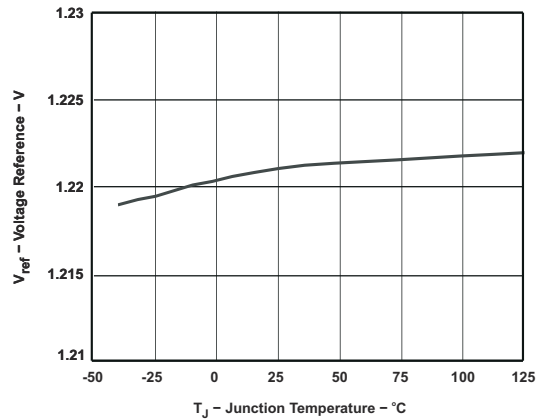

图 5-6. Internal Slow-Start Time vs Junction Temperature

5.6 Typical Characteristics (continued)

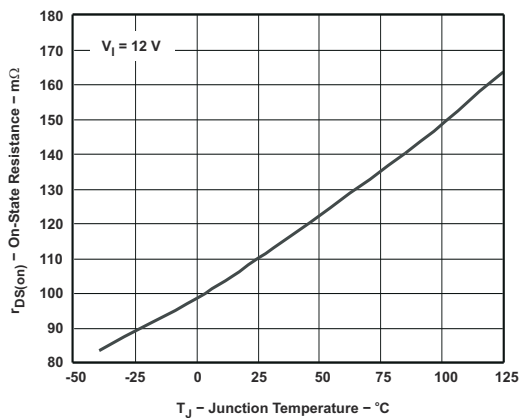

5-7. Shutdown Quiescent Current vs Input Voltage

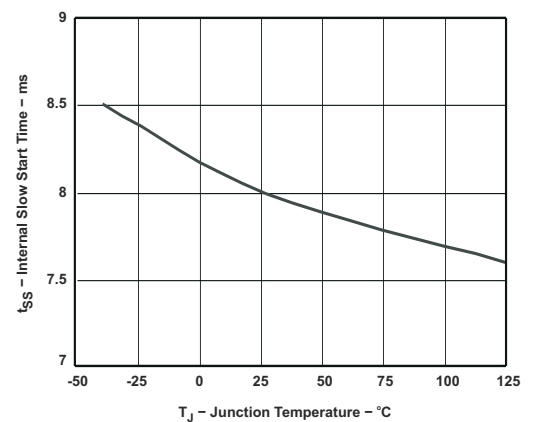
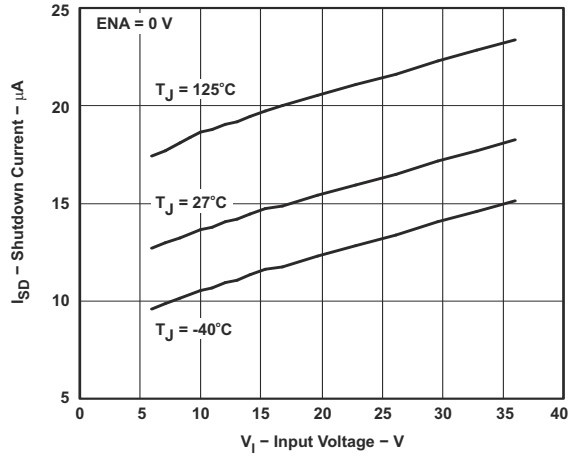
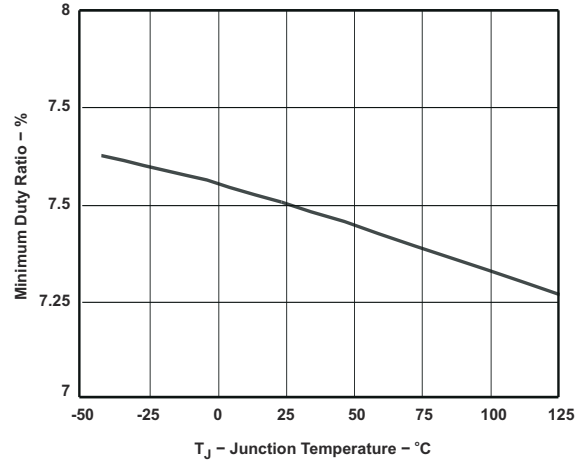

5-8. Minimum Controllable Duty Ratio vs Junction Temperature

6 Detailed Description

6.1 Overview

The TPS5410 is a 36-V, 1-A step-down (buck) regulator with an integrated, high-side, N-channel MOSFET. These devices implement constant-frequency voltage-mode control with voltage feed-forward for improved line regulation and line transient response. Internal compensation reduces design complexity and external component count.

The integrated 110-m Ω high-side MOSFET supports high-efficiency power-supply designs capable of delivering 1-A of continuous current to a load. The gate-drive bias voltage for the integrated high-side MOSFET is supplied by a bootstrap capacitor connected from the BOOT to PH pins. The TPS5410 reduces the external component count by integrating the bootstrap recharge diode.

The TPS5410 has a default input start-up voltage of 5.3-V typical. The ENA pin can be used to disable the TPS5410 reducing the supply current to 18 μ A. An internal pullup current source enables operation when the ENA pin is floating. The TPS5410 includes an internal slow-start circuit that slows the output rise time during start up to reduce inrush current and output voltage overshoot.

The minimum output voltage is the internal 1.221-V feedback reference. Output overvoltage transients are minimized by an Overvoltage Protection (OVP) comparator. When the OVP comparator is activated, the high-side MOSFET is turned off and remains off until the output voltage is less than 112.5% of the desired output voltage.

Internal cycle-by-cycle overcurrent protection limits the peak current in the integrated high-side MOSFET. For continuous overcurrent fault conditions the TPS5410 enters hiccup mode overcurrent limiting. Thermal protection protects the device from overheating.

6.2 Functional Block Diagram

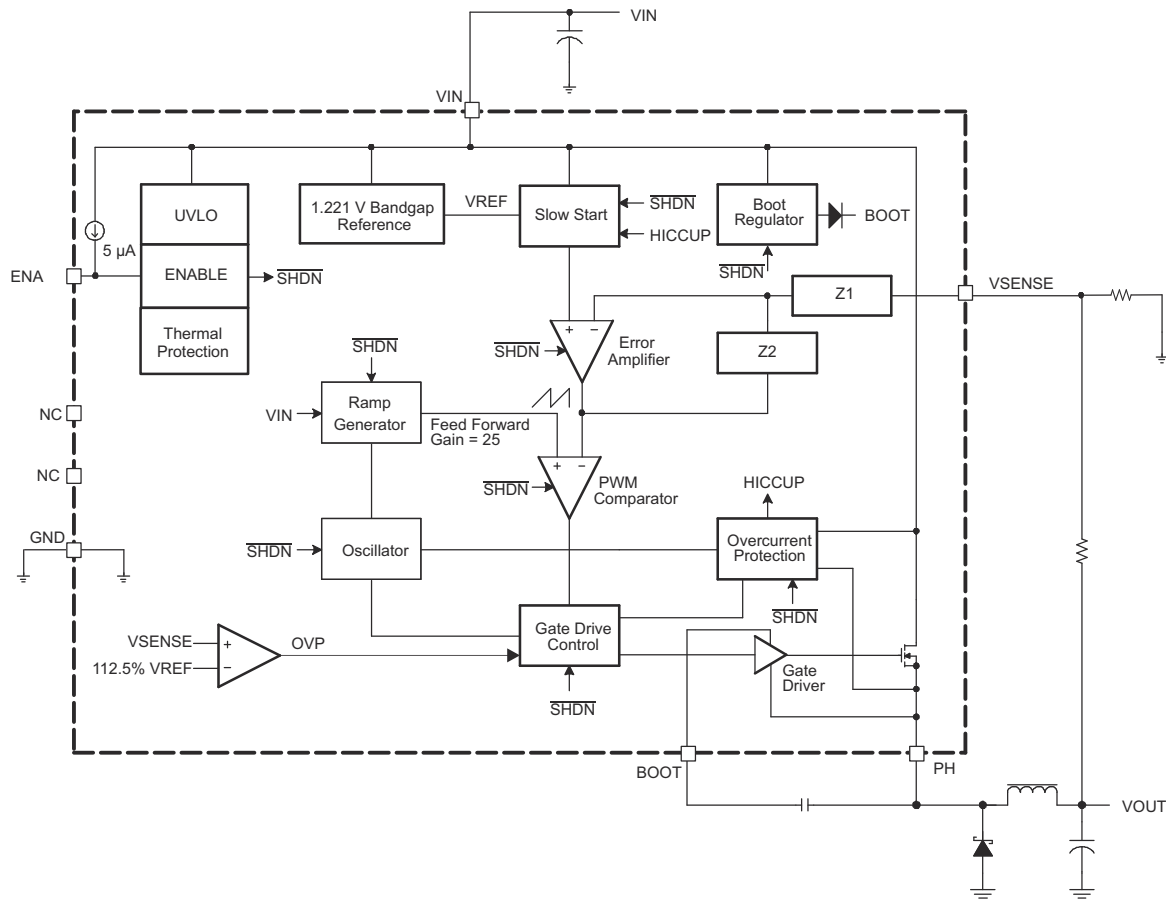

6.3 Feature Description

6.3.1 Oscillator Frequency

The internal free running oscillator sets the PWM switching frequency at 500 kHz. The 500-kHz switching frequency allows less output inductance for the same output ripple requirement resulting in a smaller output inductor.

6.3.2 Voltage Reference

The voltage reference system produces a precision reference signal by scaling the output of a temperature stable bandgap circuit. The bandgap and scaling circuits are trimmed during production testing to an output of 1.221 V at room temperature.

6.3.3 Enable (ENA) and Internal Slow-Start

The ENA pin provides electrical on/off control of the regulator. After the ENA pin voltage exceeds the threshold voltage, the regulator starts operation and the internal slow-start begins to ramp. If the ENA pin voltage is pulled below the threshold voltage, the regulator stops switching and the internal slow-start resets. Connecting the pin to ground or to any voltage less than 0.5 V disables the regulator and activate the shutdown mode. The quiescent current of the TPS5410 in shutdown mode is typically 18 µA.

The ENA pin has an internal pullup current source, allowing the user to float the ENA pin. If an application requires controlling the ENA pin, use open drain or open collector output logic to interface with the pin. To limit the start-up inrush current, an internal slow-start circuit is used to ramp up the reference voltage from 0 V to its final value linearly. The internal slow-start time is 8 ms typically.

6.3.4 Undervoltage Lockout (UVLO)

The TPS5410 incorporates an undervoltage lockout circuit to keep the device disabled when VIN (the input voltage) is below the UVLO start voltage threshold. During power up, internal circuits are held inactive and the internal slow-start is grounded until VIN exceeds the UVLO start threshold voltage. After the UVLO start threshold voltage is reached, the internal slow-start is released and device start-up begins. The device operates until VIN falls below the UVLO stop threshold voltage. The typical hysteresis in the UVLO comparator is 330 mV.

6.3.5 Boost Capacitor (BOOT)

Connect a 0.01- μ F low-ESR ceramic capacitor between the BOOT pin and PH pin. This capacitor provides the gate drive voltage for the high-side MOSFET. TI recommends X7R or X5R grade dielectrics due to their stable values over temperature.

6.3.6 Output Feedback (VSENSE)

The output voltage of the regulator is set by feeding back the center point voltage of an external resistor divider network to the VSENSE pin. In steady-state operation, the VSENSE pin voltage must be equal to the voltage reference 1.221 V.

6.3.7 Internal Compensation

The TPS5410 implements internal compensation to simplify the regulator design. Because the TPS5410 uses voltage mode control, a type 3 compensation network has been designed on chip to provide a high crossover frequency and a high phase margin for good stability. See the [セクション 7.2.1.2.7.2](#) in the Applications section for more details.

6.3.8 Voltage Feed-Forward

The internal voltage feed-forward provides a constant DC power stage gain despite any variations with the input voltage. This greatly simplifies the stability analysis and improves the transient response. Voltage feed-forward varies the peak ramp voltage inversely with the input voltage so that the modulator and power stage gain are constant at the feed-forward gain, for example:

$$\text{Feed Forward Gain} = \frac{V_{IN}}{\text{Ramp}_{\text{pk-pk}}} \quad (1)$$

The typical feed-forward gain of TPS5410 is 25.

6.3.9 Pulse-Width-Modulation (PWM) Control

The regulator employs a fixed frequency pulse-width-modulator (PWM) control method. First, the feedback voltage (VSENSE pin voltage) is compared to the constant voltage reference by the high gain error amplifier and compensation network to produce an error voltage. Then, the error voltage is compared to the ramp voltage by the PWM comparator. In this way, the error voltage magnitude is converted to a pulse width which is the duty cycle. Finally, the PWM output is fed into the gate drive circuit to control the on-time of the high-side MOSFET.

6.3.10 Overcurrent Limiting

Overcurrent limiting is implemented by sensing the drain-to-source voltage across the high-side MOSFET. The drain to source voltage is then compared to a voltage level representing the overcurrent threshold limit. If the drain-to-source voltage exceeds the overcurrent threshold limit, the overcurrent indicator is set true. The system ignores the overcurrent indicator for the leading edge blanking time at the beginning of each cycle to avoid any turn-on noise glitches.

After overcurrent indicator is set true, overcurrent limiting is triggered. The high-side MOSFET is turned off for the rest of the cycle after a propagation delay. The overcurrent limiting scheme is called cycle-by-cycle current limiting.

Sometimes under serious overload conditions such as short-circuit, the overcurrent runaway can still happen when using cycle-by-cycle current limiting. A second mode of current limiting is used, for example hiccup mode

overcurrent limiting. During hiccup mode overcurrent limiting, the voltage reference is grounded and the high-side MOSFET is turned off for the hiccup time. After the hiccup time duration is complete, the regulator restarts under control of the slow-start circuit.

6.3.11 Overvoltage Protection

The TPS5410 has an overvoltage protection (OVP) circuit to minimize voltage overshoot when recovering from output fault conditions. The OVP circuit includes an overvoltage comparator to compare the VSENSE pin voltage and a threshold of $112.5\% \times VREF$. After the VSENSE pin voltage is higher than the threshold, the high-side MOSFET is forced off. When the VSENSE pin voltage drops lower than the threshold, the high-side MOSFET enables again.

6.3.12 Thermal Shutdown

The TPS5410 protects itself from overheating with an internal thermal shutdown circuit. If the junction temperature exceeds the thermal shutdown trip point, the voltage reference is grounded and the high-side MOSFET is turned off. The part is restarted under control of the slow-start circuit automatically when the junction temperature drops 14°C below the thermal shutdown trip point.

6.4 Device Functional Modes

6.4.1 Minimum Input Voltage

TI recommends the TPS5410 to operate with input voltages above 5.5 V. The typical VIN UVLO threshold is 5.3 V and the device can operate at input voltages down to the UVLO voltage. At input voltages below the actual UVLO voltage the device do not switch. If ENA is floating or externally pulled up to greater up than 1.3 V, when $V_{(VIN)}$ passes the UVLO threshold the TPS5410 becomes active. Switching is enabled and the slow-start sequence is initiated. The TPS5410 starts linearly ramping up the internal reference voltage from 0 V to its final value over the internal slow-start time period.

6.4.2 ENA Control

The enable start threshold voltage is 1.3 V max. With ENA held below the 0.5 V minimum stop threshold voltage the TPS5410 is disabled and switching is inhibited even if VIN is above its UVLO threshold. The quiescent current is reduced in this state. If the ENA voltage is increased above the max start threshold while $V_{(VIN)}$ is above the UVLO threshold, the device becomes active. Switching is enabled and the slow-start sequence is initiated. The TPS5410 starts linearly ramping up the internal reference voltage from 0 V to its final value over the internal slow-start time period.

7 Applications and Implementation

注

以下のアプリケーション情報は、TI の製品仕様に含まれるものではなく、TI ではその正確性または完全性を保証いたしません。個々の目的に対する製品の適合性については、お客様の責任で判断していただくこととなります。お客様は自身の設計実装を検証しテストすることで、システムの機能を確認する必要があります。

7.1 Application Information

The TPS5410 is a 1-A, step down regulator with an integrated high-side MOSFET. This device is typically used to convert a higher DC voltage to a lower DC voltage with a maximum available output current of 1 A. Example applications are: High Density Point-of-Load Regulators for Set-top Box, DVD, LCD and Plasma Displays, High Power LED Supply, Car Audio, Battery Chargers, and other 12-V and 24-V Distributed Power Systems. Use the following design procedure to select component values for the TPS5410. This procedure illustrates the design of a high frequency switching regulator. Alternatively, use the WEBENCH software to generate a complete design. The WEBENCH software uses an iterative design procedure and accesses a comprehensive database of components when generating a design.

7.2 Typical Applications

7.2.1 Application Circuit

図 7-1 shows the schematic for a typical TPS5410 application. The TPS5410 can provide up to 1-A output current at a nominal output voltage of 12 V.

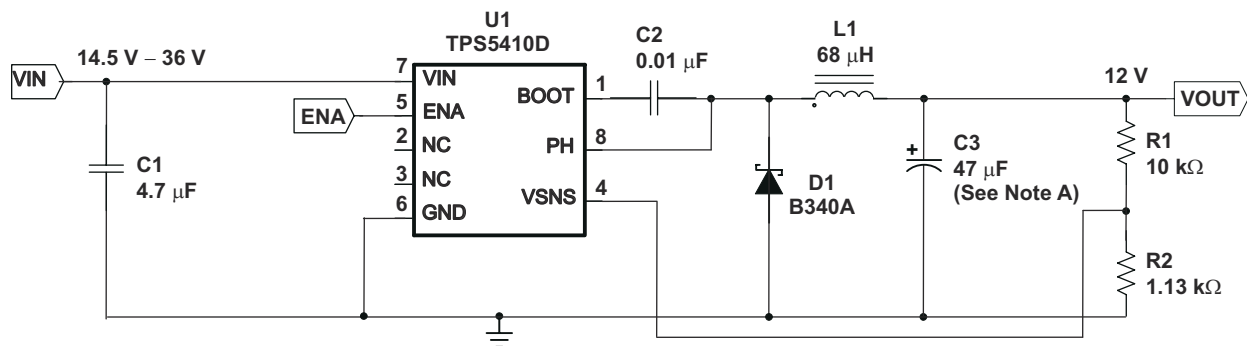

A. C3 = Tantalum AVX TPSE476M020R0150

図 7-1. Application Circuit, 14.5 V — 36 V to 12 V

7.2.1.1 Design Requirements

For this design example, use the following as the input parameters:

表 7-1. Design Requirements

DESIGN PARAMETER ⁽¹⁾	EXAMPLE VALUE
Input voltage range	14.5 V to 36 V
Output voltage	12 V
Input ripple voltage	300 mV
Output ripple voltage	50 mV
Output current rating	1 A
Operating frequency	500 kHz

(1) As an additional constraint, the design is set up to be small size and low component height.

7.2.1.2 Detailed Design Procedure

7.2.1.2.1 Switching Frequency

The switching frequency for the TPS5410 is internally set to 500 kHz. Adjusting the switching frequency is not possible.

7.2.1.2.2 Input Capacitors

The TPS5410 requires an input decoupling capacitor and, depending on the application, a bulk input capacitor. The minimum recommended value for the decoupling capacitor is 4.7 μF. A high quality ceramic type X5R or X7R is required. For some applications, a smaller value decoupling capacitor can be used, if the input voltage and current ripple ratings are not exceeded. The voltage rating must be greater than the maximum input voltage, including ripple. For this design, a 4.7 μF capacitor, C1 issued to allow for smaller 1812 case size to be used while maintaining a 50-V rating.

This input ripple voltage can be approximated by 式 2 :

$$\Delta V_{IN} = \frac{I_{OUT(MAX)} \times 0.25}{C_{BULK} \times f_{SW}} + (I_{OUT(MAX)} \times ESR_{MAX}) \quad (2)$$

Where $I_{OUT(MAX)}$ is the maximum load current, f_{SW} is the switching frequency, C_1 is the input capacitor value and ESR_{MAX} is the maximum series resistance of the input capacitor.

The maximum RMS ripple current also must be checked. For worst case conditions, this is approximated by 式 3:

$$I_{CIN} = \frac{I_{OUT(MAX)}}{2} \quad (3)$$

In this example, the calculated input ripple voltage is 137 mV, and the RMS ripple current is 0.5 A. The maximum voltage across the input capacitors is $V_{IN\ max} + \Delta V_{IN}/2$. The chosen input decoupling capacitors are rated for 50 V, and the ripple current capacity for each is 3 A at 500 kHz, providing ample margin. The actual measured input ripple voltage can be larger than the calculated value due to the output impedance of the input voltage source, decrease in actual capacitance due to bias voltage and parasitics associated with the layout.

注意

The maximum ratings for voltage and current are not to be exceeded under any circumstance.

Additionally, some bulk capacitance can be needed, especially if the TPS5410 circuit is not located within approximately 2 inches from the input voltage source. The value for this capacitor is not critical but must be rated to handle the maximum input voltage including ripple voltage and must filter the output so that input ripple voltage is acceptable.

7.2.1.2.3 Output Filter Components

Two components must be selected for the output filter, L1 and C3. Because the TPS5410 is an internally compensated device, a limited range of filter component types and values can be supported.

7.2.1.2.3.1 Inductor Selection

To calculate the minimum value of the output inductor, use 式 4:

$$L_{\text{MIN}} = \frac{V_{\text{OUT}} \times (V_{\text{IN(MAX)}} - V_{\text{OUT}})}{V_{\text{IN(max)}} \times K_{\text{IND}} \times I_{\text{OUT}} \times F_{\text{SW}} \times 0.8} \quad (4)$$

K_{IND} is a coefficient that represents the amount of inductor ripple current relative to the maximum output current. Three things must be considered when determining the amount of ripple current in the inductor: the peak to peak ripple current affects the output ripple voltage amplitude, the ripple current affects the peak switch current, and the amount of ripple current determines at what point the circuit becomes discontinuous. For designs using the TPS5410, K_{IND} of 0.2 to 0.3 yields good results. Low output ripple voltages is obtained when paired with the proper output capacitor, the peak switch current is below the current limit set point, and low load currents can be sourced before discontinuous operation.

For this design example, use $K_{\text{IND}} = 0.3$, and the minimum inductor value is 66 μH . The next highest standard value used in this design is 68 μH .

For the output filter inductor, the RMS current and saturation current ratings not being exceeded is important. The RMS inductor current can be found from 式 5:

$$I_{\text{L(RMS)}} = \sqrt{I_{\text{OUT(MAX)}}^2 + \frac{1}{12} \times \left(\frac{V_{\text{OUT}} \times (V_{\text{IN(MAX)}} - V_{\text{OUT}})}{V_{\text{IN(MAX)}} \times L_{\text{OUT}} \times F_{\text{SW}} \times 0.8} \right)^2} \quad (5)$$

and the peak inductor current can be determined using 式 6:

$$I_{\text{L(PK)}} = I_{\text{OUT(MAX)}} + \frac{V_{\text{OUT}} \times (V_{\text{IN(MAX)}} - V_{\text{OUT}})}{1.6 \times V_{\text{IN(MAX)}} \times L_{\text{OUT}} \times F_{\text{SW}}} \quad (6)$$

For this design, the RMS inductor current is 1.004 A, and the peak inductor current is 1.147 A. The chosen inductor is a Coilcraft MSS1260-683 type. The nominal inductance is 68 μH . It has a saturation current rating of 2.3 A and a RMS current rating of 2.3 A, which meets the requirements. Inductor values for use with the TPS5410 are in the range of 10 μH to 100 μH .

7.2.1.2.3.2 Capacitor Selection

The important design factors for the output capacitor are dc voltage rating, ripple current rating, and equivalent series resistance (ESR). The dc voltage and ripple current ratings cannot be exceeded. The ESR is important because along with the inductor ripple current it determines the amount of output ripple voltage. The actual value of the output capacitor is not critical, but some practical limits do exist. Consider the relationship between the desired closed loop crossover frequency of the design and LC corner frequency of the output filter. Due to the design of the internal compensation, TI recommends to keep the closed loop crossover frequency in the range 3 kHz to 30 kHz as this frequency range has adequate phase boost to allow for stable operation. For this design

example, the intended closed loop crossover frequency is between 2590 Hz and 24 kHz, and below the ESR zero of the output capacitor. Under these conditions, the closed loop crossover frequency is related to the LC corner frequency as:

$$f_{CO} = \frac{f_{LC}^2}{85 V_{OUT}} \quad (7)$$

and the desired output capacitor value for the output filter to:

$$C_{OUT} = \frac{1}{3357 \times L_{OUT} \times f_{CO} \times V_{OUT}} \quad (8)$$

For a desired crossover of 10 kHz and a 68-μH inductor, the calculated value for the output capacitor is 36.5 μF. The capacitor type must be chosen so that the ESR zero is above the loop crossover. The maximum ESR is:

$$ESR_{MAX} = \frac{1}{2\pi \times C_{OUT} \times f_{CO}} \quad (9)$$

The maximum ESR of the output capacitor also determines the amount of output ripple as specified in the initial design parameters. The output ripple voltage is the inductor ripple current times the ESR of the output filter. Check that the maximum specified ESR as listed in the capacitor data sheet results in an acceptable output ripple voltage:

$$V_{PP(MAX)} = \frac{ESR_{MAX} \times V_{OUT} \times (V_{IN(MAX)} - V_{OUT})}{N_C \times V_{IN(MAX)} \times L_{OUT} \times F_{SW} \times 0.8} \quad (10)$$

Where:

ΔV_{PP} is the desired peak-to-peak output ripple.

N_C is the number of parallel output capacitors.

F_{SW} is the switching frequency.

The minimum ESR of the output capacitor must also be considered. For a good phase margin, if the ESR is zero when the ESR is at its minimum, it must not be above the internal compensation poles at 24 kHz and 54 kHz.

The selected output capacitor must also be rated for a voltage greater than the desired output voltage plus one half the ripple voltage. Any derating amount must also be included. The maximum RMS ripple current in the output capacitor is given by 式 11:

$$I_{COUT(RMS)} = \frac{1}{\sqrt{12}} \times \left[\frac{V_{OUT} \times (V_{IN(MAX)} - V_{OUT})}{V_{IN(MAX)} \times L_{OUT} - F_{SW} \times 0.8 \times N_C} \right] \quad (11)$$

Where:

N_C is the number of output capacitors in parallel.

F_{SW} is the switching frequency.

For this design example, a single 47-μF output capacitor is chosen for C3. This value is close to the calculated value of 36.5 μF and yields an actual closed loop cross over frequency of 10.05 kHz. The calculated RMS ripple current is 84.9 mA and the maximum ESR required is 339 mΩ. A capacitor that meets these requirements is a

AVX TPSE476M020R0150, rated at 20 V with a maximum ESR of 150 mΩ and a ripple current rating of 1.369 A. This capacitor results in a peak-to-peak output ripple of 44 mV using equation 10. An additional small 0.1-μF ceramic bypass capacitor can also be used, but is not included in this design.

Other capacitor types can be used with the TPS5410, depending on the needs of the application.

7.2.1.2.4 Output Voltage Setpoint

The output voltage of the TPS5410 is set by a resistor divider (R1 and R2) from the output to the VSENSE pin. Calculate the R2 resistor value for the output voltage of 12 V using 式 12:

$$R2 = \frac{R1 \times 1.221}{V_{OUT} - 1.221} \quad (12)$$

For any TPS5410 design, start with an R1 value of 10 kΩ. R2 is then 1.13 kΩ.

7.2.1.2.5 Boot Capacitor

The boot capacitor must be 0.01 μF.

7.2.1.2.6 Catch Diode

The TPS5410 is designed to operate using an external catch diode between PH and GND. The selected diode must meet the absolute maximum ratings for the application: Reverse voltage must be higher than the maximum voltage at the PH pin, which is $V_{INMAX} + 0.5$ V. Peak current must be greater than I_{OUTMAX} plus on half the peak-to-peak inductor current. Forward voltage drop must be small for higher efficiencies. It is important to note that the catch diode conduction time is typically longer than the high-side FET on time; therefore, the diode parameters improve the overall efficiency. Additionally, check that the device chosen is capable of dissipating the power losses. For this design, a Diodes, Inc. B340A is chosen, with a reverse voltage of 40 V, forward current of 3 A, and a forward voltage drop of 0.5 V.

7.2.1.2.7 Advanced Information

7.2.1.2.7.1 Output Voltage Limitations

Due to the internal design of the TPS5410, there are both upper and lower output voltage limits for any given input voltage. The upper limit of the output voltage set point is constrained by the maximum duty cycle of 87% and is given by:

$$V_{OUTMAX} = 0.87 \times \left((V_{INMIN} - I_{OMAX} \times 0.230) + V_D \right) - (I_{OMAX} \times R_L) - V_D \quad (13)$$

Where:

V_{INMIN} = minimum input voltage

I_{OMAX} = maximum load current

V_D = catch diode forward voltage.

R_L = output inductor series resistance.

This equation assumes maximum on resistance for the internal high side FET.

The lower limit is constrained by the minimum controllable on time which can be as high as 200 ns. The approximate minimum output voltage for a given input voltage and minimum load current is given by:

$$V_{OUTMIN} = 0.12 \times \left((V_{INMAX} - I_{OMIN} \times 0.110) + V_D \right) - (I_{OMIN} \times R_L) - V_D \quad (14)$$

Where:

V_{INMAX} = maximum input voltage

I_{OMIN} = minimum load current

V_D = catch diode forward voltage.

R_L = output inductor series resistance.

This equation assumes nominal on resistance for the high side FET and accounts for worst case variation of operating frequency set point. Any design operating near the operational limits of the device must be checked to assure proper functionality.

7.2.1.2.7.2 Internal Compensation Network

The design equations given in the example circuit can be used to generate circuits using the TPS5410. These designs are based on certain assumptions, and always select output capacitors within a limited range of ESR values. If a different capacitor type is desired, it can be possible to fit one to the internal compensation of the TPS5410. 式 15 gives the nominal frequency response of the internal voltage-mode type III compensation network:

$$H(s) = \frac{\left(1 + \frac{s}{2\pi \times Fz1}\right) \times \left(1 + \frac{s}{2\pi \times Fz2}\right)}{\left(\frac{s}{2\pi \times Fp0}\right) \times \left(1 + \frac{s}{2\pi \times Fp1}\right) \times \left(1 + \frac{s}{2\pi \times Fp2}\right) \times \left(1 + \frac{s}{2\pi \times Fp3}\right)} \quad (15)$$

Where

$Fp0 = 2165 \text{ Hz}$, $Fz1 = 2170 \text{ Hz}$, $Fz2 = 2590 \text{ Hz}$

$Fp1 = 24 \text{ kHz}$, $Fp2 = 54 \text{ kHz}$, $Fp3 = 440 \text{ kHz}$

$Fp3$ represents the non-ideal parasitics effect.

Using this information along with the desired output voltage, feed-forward gain and output filter characteristics, the closed loop transfer function can be derived.

7.2.1.2.7.3 Thermal Calculations

The following formulas show how to estimate the device power dissipation under continuous conduction mode operations. Do not use the formulas if the device is working at light loads in the discontinuous conduction mode.

Conduction Loss: $P_{con} = I_{OUT}^2 \times R_{ds(on)} \times V_{OUT} / V_{IN}$

Switching Loss: $P_{sw} = V_{IN} \times I_{OUT} \times 0.01$



Quiescent Current Loss: $P_q = V_{IN} \times 0.01$

Total Loss: $P_{tot} = P_{con} + P_{sw} + P_q$

Given $T_A \Rightarrow$ Estimated Junction Temperature: $T_J = T_A + R_{th} \times P_{tot}$

Given $T_{JMAX} = 125^\circ\text{C} \Rightarrow$ Estimated Maximum Ambient Temperature: $T_{AMAX} = T_{JMAX} - R_{th} \times P_{tot}$

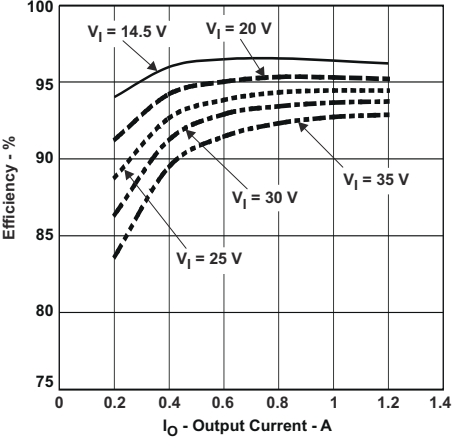
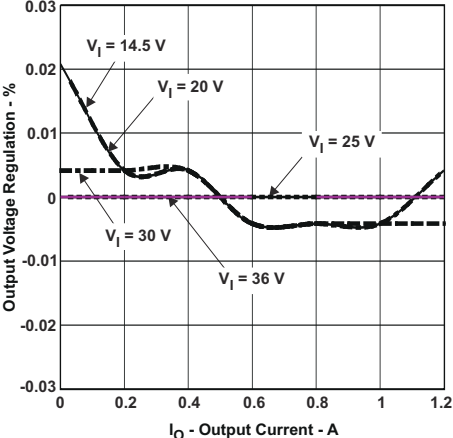
7.2.1.3 Application Curves

The performance graphs in  to  are applicable to the circuit in . $T_A = 25\text{ }^\circ\text{C}$. unless otherwise specified.

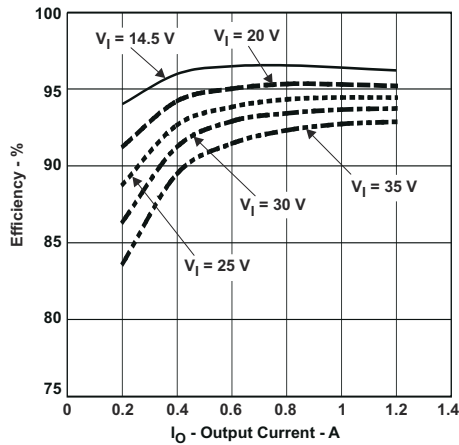

 **7-2. Efficiency vs Output Current**

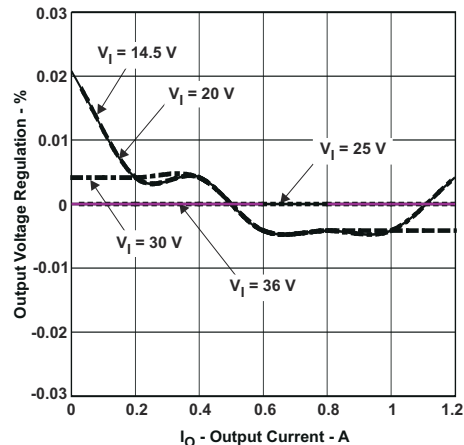

 **7-3. Output Voltage Regulation % vs Output Current**

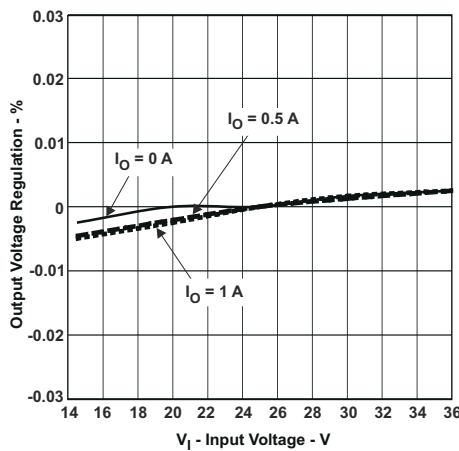

 **7-4. Output Voltage Regulation % vs Input Voltage**

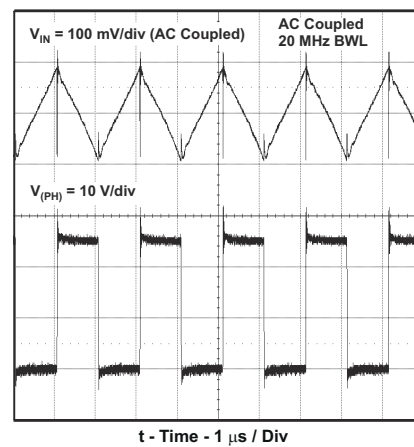

 **7-5. Input Voltage Ripple and PH Node, $I_O = 1\text{ A}$**

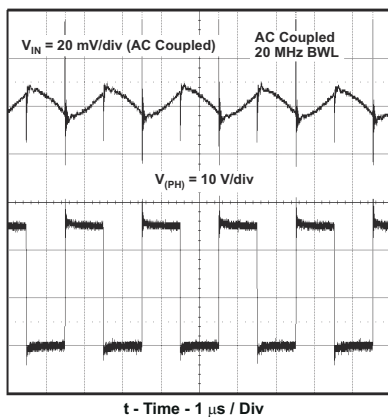

 **7-6. Output Voltage Ripple and PH Node, $I_O = 1\text{ A}$**

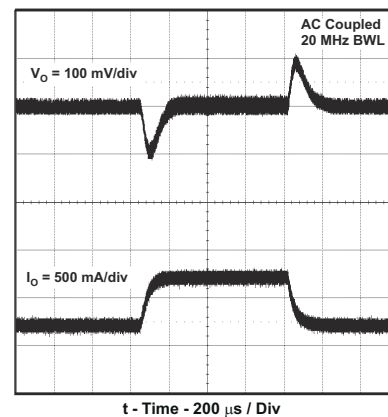

 **7-7. Transient Response, I_O Step 0.25 to 0.75 A**



図 7-8. Start-up Waveform, V_I and V_O



図 7-9. Start-up Waveform, ENA and V_O

7.2.2 Using All Ceramic Capacitors

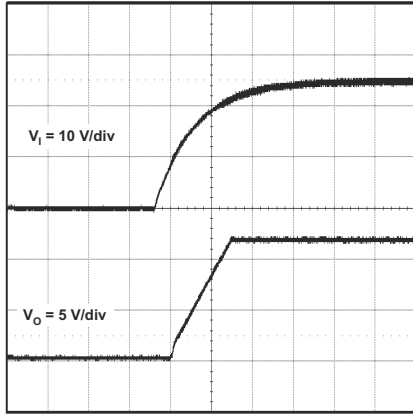
Figure 7-10 shows an application circuit using all ceramic capacitors for the input and output filters. The design procedure is similar to those given for the design example, except for the selection of the output filter capacitor values and the design of the additional compensation components required to stabilize the circuit.

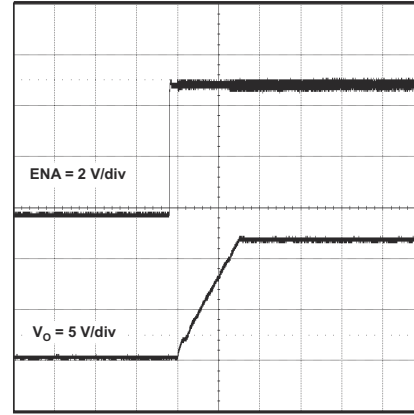
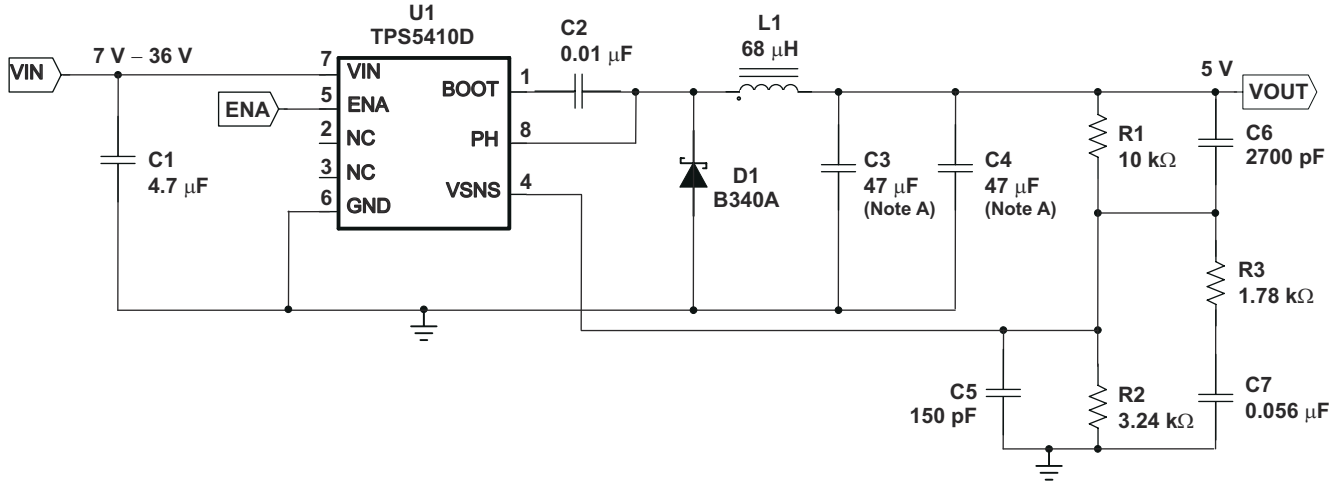

A. C3, C4 = Ceramic TDKC4532X5R1A476MT

Figure 7-10. 7-V — 36-V Input to 5-V Output Application Circuit with Ceramic Capacitors

7.2.2.1 Design Requirements

For this design example, use Table 7-1 as the input parameters.

7.2.2.2 Detailed Design Procedure

7.2.2.2.1 Output Filter Capacitor Selection

When using ceramic output filter capacitors, the recommended LC resonant frequency must be no more than 7 kHz. Because the output inductor is already selected at 68 μH, this limits the minimum output capacitor value to:

$$C_O \text{ (MIN)} \geq \frac{1}{(2\pi \times 7000)^2 \times L_O} \quad (16)$$

The minimum capacitor value is calculated to be 7.6 μF. For this circuit a larger value of capacitor yields better transient response. Two output capacitors are used for C3 and C4 with a value of 47 uF each. Note that the actual capacitance of ceramic capacitors decreases with applied voltage. In this case the effective value used for the calculations is approximately 70 % of the rated value or 70 μF.

7.2.2.2.2 External Compensation Network

When using ceramic output capacitors, additional circuitry is required to stabilize the closed loop system. For this circuit the external components are R3, C5, C6 and C7. To determine the value of these components, first calculate the LC resonant frequency of the output filter:

$$F_{LC} = \frac{1}{2\pi \sqrt{L_O \times C_O \text{ (EFF)}}} \quad (17)$$

For this example the effective resonant frequency is calculated as 2306 Hz

The network composed of R1, R2, R3, C5, C6 and C7 has two poles and two zeros that are used to tailor the overall response of the feedback network to accommodate the use of the ceramic output capacitors. The pole and zero locations are given by the following equations:

$$F_{p1} = 500000 \times \frac{V_O}{F_{LC}} \quad (18)$$

$$F_{z1} = 0.7 \times F_{LC} \quad (19)$$

$$F_{z2} = 2.5 \times F_{LC} \quad (20)$$

The final pole is located at a frequency too high to be of concern. The values for R1 and R2 are fixed by the 5-V output voltage as calculated using 式 12. Now the values of R3, C5, C6 and C7 are determined using 式 21, 式 22, and 式 23:

$$C7 = \frac{1}{2\pi \times F_{p1} \times (R1 \parallel R2)} \quad (21)$$



$$R3 = \frac{1}{2\pi \times F_{z1} \times C7} \quad (22)$$

$$C6 = \frac{1}{2\pi \times F_{z2} \times R1} \quad (23)$$

For this design, using the closest standard values, C7 is 0.056 μ F, R3 is 1.76 k Ω and C6 is 2700 pF. C5 is added to improve load regulation performance. C5 is effectively in parallel with C6 in the location of the second pole frequency, so it must be small in relationship to C6. C5 must be less than 1/10 the value of C6. For this example, 150 pF works well.

For additional information on external compensation of the TPS5410 or other wide voltage range devices, see [Using TPS5410/20/30/31/50 With Aluminum/Ceramic Output Capacitors](#) application report.

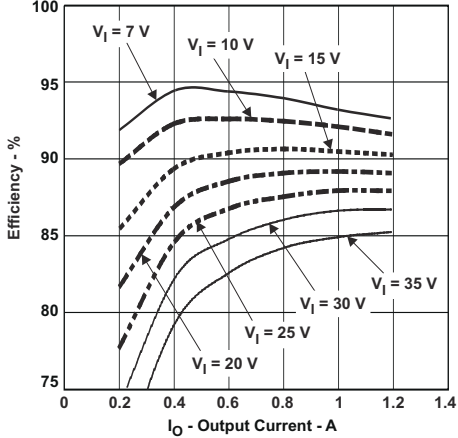
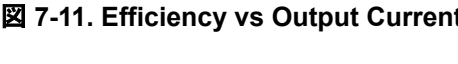
7.2.2.3 Application Curves

The performance graphs in  to  are applicable to the circuit in . $T_A = 25\text{ }^\circ\text{C}$. unless otherwise specified.

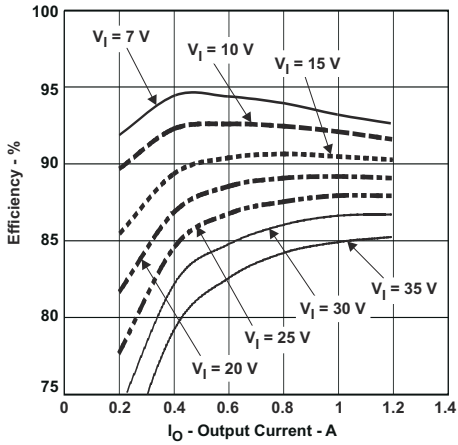

 7-11. Efficiency vs Output Current

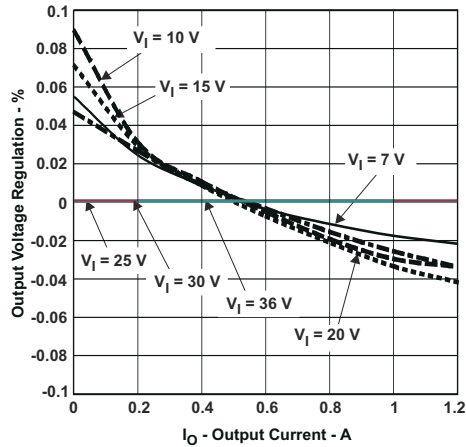

 7-12. Output Voltage Regulation % vs Output Current

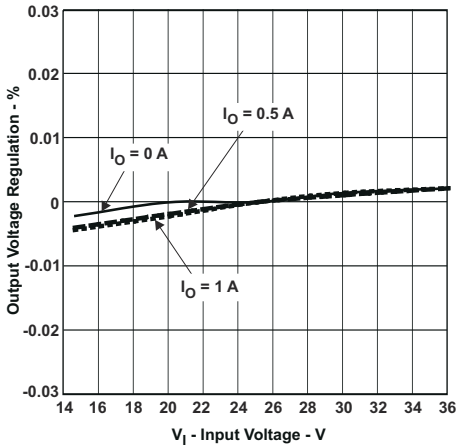

 7-13. Output Voltage Regulation % vs Input Voltage

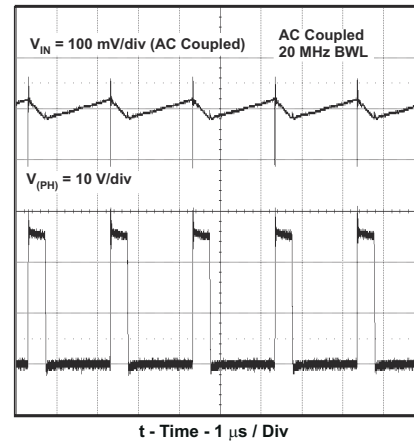

 7-14. Input Voltage Ripple and PH Node, $I_O = 1\text{ A}$

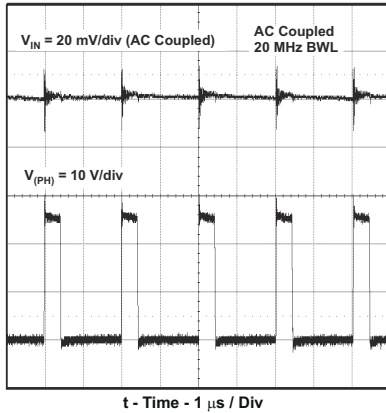

7-15. Output Voltage Ripple and PH Node, $I_O = 1$ A

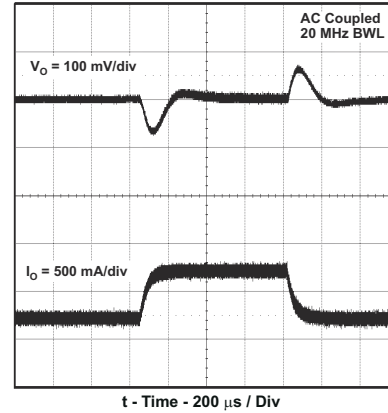

7-16. Transient Response, I_O Step 0.25 to 0.75 A

7.3 Power Supply Recommendations

The TPS5410 is designed to operate from an input voltage supply range between 5.5 V and 36 V. This input supply must remain within the input voltage supply range. If the input supply is located more than a few inches from the TPS5410 converter bulk capacitance can be required in addition to the ceramic bypass capacitors. An electrolytic capacitor with a value of 100 μ F is a typical choice.

7.4 Layout

7.4.1 Layout Guidelines

Connect a low ESR ceramic bypass capacitor to the VIN pin. Care must be taken to minimize the loop area formed by the bypass capacitor connections, the VIN pin, and the TPS5410 ground pin. The best way to do this is to extend the top side ground area from under the device adjacent to the VIN trace, and place the bypass capacitor as close as possible to the VIN pin. The minimum recommended bypass capacitance is 4.7 μ F ceramic with a X5R or X7R dielectric.

There must be a ground area on the top layer directly underneath the IC to connect the GND pin of the device and the anode of the catch diode. Tie the GND pin to the PCB ground by connecting it to the ground area under the device as shown in [7-17](#).

Route the PH pin to the output inductor, catch diode and boot capacitor. Because the PH connection is the switching node, the inductor must be located close to the PH pin, and the area of the PCB conductor minimized to prevent excessive capacitive coupling. The catch diode must also be placed close to the device to minimize the output current loop area. Connect the boot capacitor between the phase node and the BOOT pin as shown. Keep the boot capacitor close to the IC and minimize the conductor trace lengths. The component placements and connections shown work well, but other connection routings can also be effective.

Connect the output filter capacitors as shown between the VOUT trace and GND. Keep the loop formed by the PH pin, Lout, Cout and GND as small as is practical.

Connect the VOUT trace to the VSENSE pin using the resistor divider network to set the output voltage. Do not route this trace too close to the PH trace. Due to the size of the IC package and the device pinout, the trace can be routed under the output capacitor. The routing can be done on an alternate layer if a trace under the output capacitor is not desired.

If the grounding scheme shown is used through a connection to a different layer to route to the ENA pin.

7.4.2 Layout Example

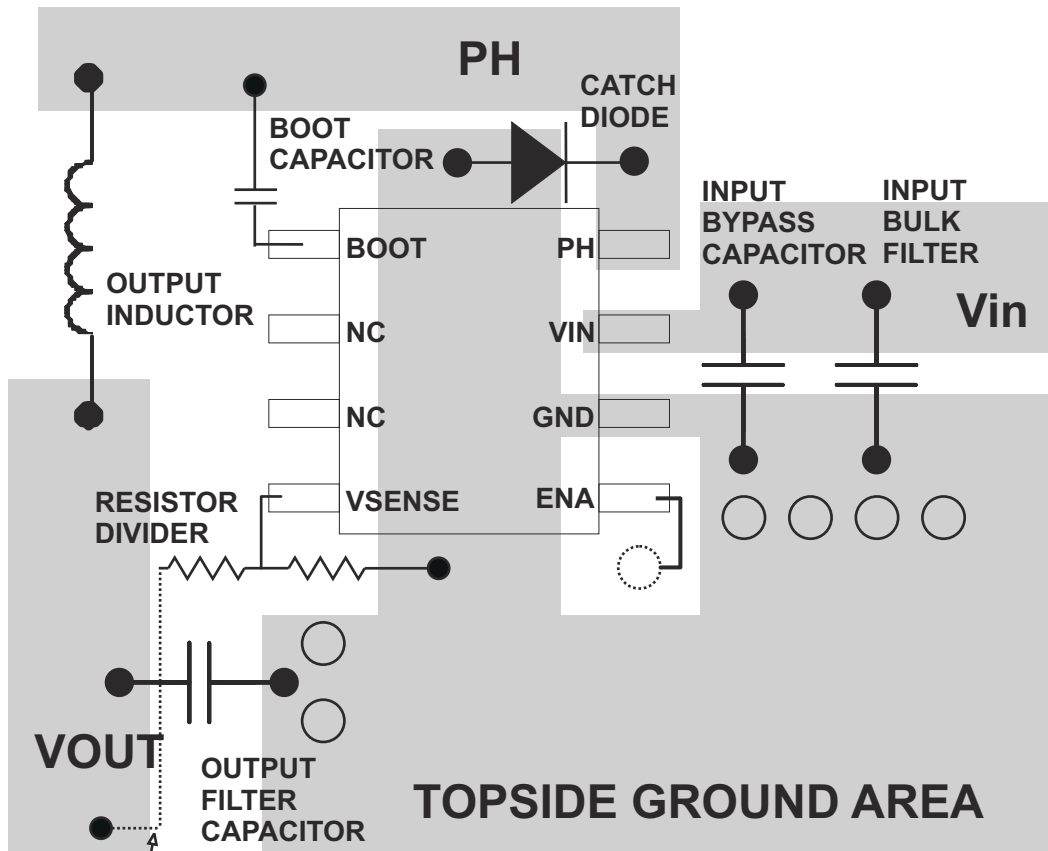

Route feedback trace under the output filter capacitor or on the other layer.

○ VIA to Ground Plane

○ Signal VIA

7-17. Design Layout

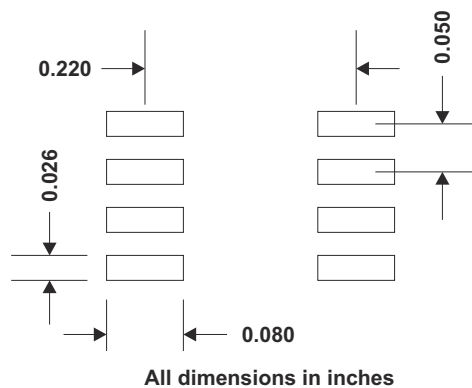

7-18. TPS5410 Land Pattern

8 Device and Documentation Support

8.1 Documentation Support

8.1.1 Related Documentation

Texas Instruments, [Using TPS5410/20/30/31/50 With Aluminum/Ceramic Output Capacitors](#) application report

8.2 ドキュメントの更新通知を受け取る方法

ドキュメントの更新についての通知を受け取るには、www.tij.co.jp のデバイス製品フォルダを開いてください。[通知] をクリックして登録すると、変更されたすべての製品情報に関するダイジェストを毎週受け取ることができます。変更の詳細については、改訂されたドキュメントに含まれている改訂履歴をご覧ください。

8.3 サポート・リソース

テキサス・インスツルメンツ E2E™ サポート・フォーラムは、エンジニアが検証済みの回答と設計に関するヒントをエキスパートから迅速かつ直接得ることができる場所です。既存の回答を検索したり、独自の質問をしたりすることで、設計に必要な支援を迅速に得ることができます。

リンクされているコンテンツは、各寄稿者により「現状のまま」提供されるものです。これらはテキサス・インスツルメンツの仕様を構成するものではなく、必ずしもテキサス・インスツルメンツの見解を反映したものではありません。テキサス・インスツルメンツの[使用条件](#)を参照してください。

8.4 Trademarks

テキサス・インスツルメンツ E2E™ is a trademark of Texas Instruments.

すべての商標は、それぞれの所有者に帰属します。

8.5 静電気放電に関する注意事項



この IC は、ESD によって破損する可能性があります。テキサス・インスツルメンツは、IC を取り扱う際には常に適切な注意を払うことを推奨します。正しい取り扱いおよび設置手順に従わない場合、デバイスを破損するおそれがあります。

ESD による破損は、わずかな性能低下からデバイスの完全な故障まで多岐にわたります。精密な IC の場合、パラメータがわずかに変化するだけで公表されている仕様から外れる可能性があるため、破損が発生しやすくなっています。

8.6 用語集

[テキサス・インスツルメンツ用語集](#) この用語集には、用語や略語の一覧および定義が記載されています。

9 Revision History

資料番号末尾の英字は改訂を表しています。その改訂履歴は英語版に準じています。

Changes from Revision D (November 2014) to Revision E (January 2024)	Page
ドキュメント全体にわたって表、図、相互参照の採番方法を更新.....	1
Updated to new format which does not include specific parameter names and does include min and max columns; TJ called out in header Pin names are used rather than signal names; BOOT and PH voltages now marked as output voltage; Footnotes updated and Note 2 removed.....	3
Changed BOOT to PH Absolute Maximum to 6 V maximum.....	3
Changed CDM ESD to ± 750 V.....	4
Added Recommended operating V_I input voltage.....	4
Updated footnotes to match current TI standards, replaced custom board specifications with EVM information and JEDEC standard information.....	4
Changed $R_{\theta JC(top)}$, $R_{\theta JB}$, Ψ_{JT} , Ψ_{JB}	4
Added condition for typical specifications EC table's header, added parameter names, and used pin names in parameter descriptions. Footnote added.....	4
Updated the following test conditions: V_{FB} , D_{MAX} , and $R_{DSON(HS)}$	4
Updated the following typical specifications in the EC table: $I_{Q(VIN)}$, $I_{SD(VIN)}$, $V_{INUVLO(H)}$, $V_{EN(H)}$, and $R_{DSON(HS)}$	4

- Updated typical and maximum ISH(OC) in the EC table.....4
-

Changes from Revision C (September 2013) to Revision D (November 2014) Page

- 「ESD 定格」表、「機能説明」セクション、「デバイスの機能モード」セクション、「アプリケーションと実装」セクション、「電源に関する推奨事項」セクション、「レイアウト」セクション、「デバイスおよびドキュメントのサポート」セクション、「メカニカル、パッケージ、および注文情報」セクションを追加。.....1
-

Changes from Revision B (January 2013) to Revision C (September 2013) Page

- データシートのタイトル、「特長」、「概要」から「SWIFT」を削除.....1
 - Updated the following test conditions: V_{FB} , D_{MAX} , and $R_{DSON(HS)}$4
-

10 Mechanical, Packaging, and Orderable Information

The following pages include mechanical, packaging, and orderable information. This information is the most current data available for the designated devices. This data is subject to change without notice and revision of this document. For browser-based versions of this data sheet, refer to the left-hand navigation.

重要なお知らせと免責事項

テキサス・インスツルメンツは、技術データと信頼性データ (データシートを含みます)、設計リソース (リファレンス デザインを含みます)、アプリケーションや設計に関する各種アドバイス、Web ツール、安全性情報、その他のリソースを、欠陥が存在する可能性のある「現状のまま」提供しており、商品性および特定目的に対する適合性の黙示保証、第三者の知的財産権の非侵害保証を含むいかなる保証も、明示的または黙示的にかかわらず拒否します。

これらのリソースは、テキサス・インスツルメンツ製品を使用する設計の経験を積んだ開発者への提供を意図したものです。(1) お客様のアプリケーションに適した テキサス・インスツルメンツ製品の選定、(2) お客様のアプリケーションの設計、検証、試験、(3) お客様のアプリケーションに該当する各種規格や、その他のあらゆる安全性、セキュリティ、規制、または他の要件への確実な適合に関する責任を、お客様のみが単独で負うものとします。

上記の各種リソースは、予告なく変更される可能性があります。これらのリソースは、リソースで説明されている テキサス・インスツルメンツ製品を使用するアプリケーションの開発の目的でのみ、テキサス・インスツルメンツはその使用をお客様に許諾します。これらのリソースに関して、他の目的で複製することや掲載することは禁止されています。テキサス・インスツルメンツや第三者の知的財産権のライセンスが付与されている訳ではありません。お客様は、これらのリソースを自身で使用した結果発生するあらゆる申し立て、損害、費用、損失、責任について、テキサス・インスツルメンツおよびその代理人を完全に補償するものとし、テキサス・インスツルメンツは一切の責任を拒否します。

テキサス・インスツルメンツの製品は、[テキサス・インスツルメンツの販売条件](#)、または [ti.com](https://www.ti.com) やかかる テキサス・インスツルメンツ製品の関連資料などのいずれかを通じて提供する適用可能な条項の下で提供されています。テキサス・インスツルメンツがこれらのリソースを提供することは、適用されるテキサス・インスツルメンツの保証または他の保証の放棄の拡大や変更を意味するものではありません。

お客様がいかなる追加条項または代替条項を提案した場合でも、テキサス・インスツルメンツはそれらに異議を唱え、拒否します。

郵送先住所: Texas Instruments, Post Office Box 655303, Dallas, Texas 75265
Copyright © 2024, Texas Instruments Incorporated

PACKAGING INFORMATION

Orderable part number	Status (1)	Material type (2)	Package Pins	Package qty Carrier	RoHS (3)	Lead finish/ Ball material (4)	MSL rating/ Peak reflow (5)	Op temp (°C)	Part marking (6)
TPS5410D	Active	Production	SOIC (D) 8	75 TUBE	Yes	NIPDAU NIPDAU	Level-2-260C-1 YEAR	-40 to 125	(5410, TPS5410)
TPS5410DR	Active	Production	SOIC (D) 8	2500 LARGE T&R	Yes	NIPDAU NIPDAU	Level-2-260C-1 YEAR	-40 to 125	(5410, TPS5410)

(1) **Status:** For more details on status, see our [product life cycle](#).

(2) **Material type:** When designated, preproduction parts are prototypes/experimental devices, and are not yet approved or released for full production. Testing and final process, including without limitation quality assurance, reliability performance testing, and/or process qualification, may not yet be complete, and this item is subject to further changes or possible discontinuation. If available for ordering, purchases will be subject to an additional waiver at checkout, and are intended for early internal evaluation purposes only. These items are sold without warranties of any kind.

(3) **RoHS values:** Yes, No, RoHS Exempt. See the [TI RoHS Statement](#) for additional information and value definition.

(4) **Lead finish/Ball material:** Parts may have multiple material finish options. Finish options are separated by a vertical ruled line. Lead finish/Ball material values may wrap to two lines if the finish value exceeds the maximum column width.

(5) **MSL rating/Peak reflow:** The moisture sensitivity level ratings and peak solder (reflow) temperatures. In the event that a part has multiple moisture sensitivity ratings, only the lowest level per JEDEC standards is shown. Refer to the shipping label for the actual reflow temperature that will be used to mount the part to the printed circuit board.

(6) **Part marking:** There may be an additional marking, which relates to the logo, the lot trace code information, or the environmental category of the part.

Multiple part markings will be inside parentheses. Only one part marking contained in parentheses and separated by a "~" will appear on a part. If a line is indented then it is a continuation of the previous line and the two combined represent the entire part marking for that device.

Important Information and Disclaimer:The information provided on this page represents TI's knowledge and belief as of the date that it is provided. TI bases its knowledge and belief on information provided by third parties, and makes no representation or warranty as to the accuracy of such information. Efforts are underway to better integrate information from third parties. TI has taken and continues to take reasonable steps to provide representative and accurate information but may not have conducted destructive testing or chemical analysis on incoming materials and chemicals. TI and TI suppliers consider certain information to be proprietary, and thus CAS numbers and other limited information may not be available for release.

In no event shall TI's liability arising out of such information exceed the total purchase price of the TI part(s) at issue in this document sold by TI to Customer on an annual basis.

OTHER QUALIFIED VERSIONS OF TPS5410 :

- Automotive : [TPS5410-Q1](#)

- Enhanced Product : [TPS5410-EP](#)

NOTE: Qualified Version Definitions:

- Automotive - Q100 devices qualified for high-reliability automotive applications targeting zero defects
- Enhanced Product - Supports Defense, Aerospace and Medical Applications

TAPE AND REEL INFORMATION



QUADRANT ASSIGNMENTS FOR PIN 1 ORIENTATION IN TAPE



*All dimensions are nominal

Device	Package Type	Package Drawing	Pins	SPQ	Reel Diameter (mm)	Reel Width W1 (mm)	A0 (mm)	B0 (mm)	K0 (mm)	P1 (mm)	W (mm)	Pin1 Quadrant
TPS5410DR	SOIC	D	8	2500	330.0	12.4	6.4	5.2	2.1	8.0	12.0	Q1
TPS5410DR	SOIC	D	8	2500	330.0	12.4	6.4	5.2	2.1	8.0	12.0	Q1

TAPE AND REEL BOX DIMENSIONS

*All dimensions are nominal

Device	Package Type	Package Drawing	Pins	SPQ	Length (mm)	Width (mm)	Height (mm)
TPS5410DR	SOIC	D	8	2500	353.0	353.0	32.0
TPS5410DR	SOIC	D	8	2500	356.0	356.0	35.0

TUBE

*All dimensions are nominal

Device	Package Name	Package Type	Pins	SPQ	L (mm)	W (mm)	T (μm)	B (mm)
TPS5410D	D	SOIC	8	75	506.6	8	3940	4.32
TPS5410DG4	D	SOIC	8	75	506.6	8	3940	4.32



D0008A

PACKAGE OUTLINE

SOIC - 1.75 mm max height

SMALL OUTLINE INTEGRATED CIRCUIT



4214825/C 02/2019

NOTES:

- Linear dimensions are in inches [millimeters]. Dimensions in parenthesis are for reference only. Controlling dimensions are in inches. Dimensioning and tolerancing per ASME Y14.5M.
- This drawing is subject to change without notice.
- This dimension does not include mold flash, protrusions, or gate burrs. Mold flash, protrusions, or gate burrs shall not exceed $.006$ [0.15] per side.
- This dimension does not include interlead flash.
- Reference JEDEC registration MS-012, variation AA.

EXAMPLE BOARD LAYOUT

D0008A

SOIC - 1.75 mm max height

SMALL OUTLINE INTEGRATED CIRCUIT



LAND PATTERN EXAMPLE
EXPOSED METAL SHOWN
SCALE:8X



SOLDER MASK DETAILS

4214825/C 02/2019

NOTES: (continued)

6. Publication IPC-7351 may have alternate designs.

7. Solder mask tolerances between and around signal pads can vary based on board fabrication site.

EXAMPLE STENCIL DESIGN

D0008A

SOIC - 1.75 mm max height

SMALL OUTLINE INTEGRATED CIRCUIT



SOLDER PASTE EXAMPLE
BASED ON .005 INCH [0.125 MM] THICK STENCIL
SCALE:8X

4214825/C 02/2019

NOTES: (continued)

8. Laser cutting apertures with trapezoidal walls and rounded corners may offer better paste release. IPC-7525 may have alternate design recommendations.
9. Board assembly site may have different recommendations for stencil design.

重要なお知らせと免責事項

テキサス・インスツルメンツは、技術データと信頼性データ(データシートを含みます)、設計リソース(リファレンス デザインを含みます)、アプリケーションや設計に関する各種アドバイス、Web ツール、安全性情報、その他のリソースを、欠陥が存在する可能性のある「現状のまま」提供しており、商品性および特定目的に対する適合性の黙示保証、第三者の知的財産権の非侵害保証を含むいかなる保証も、明示的または黙示的にかかわらず拒否します。

これらのリソースは、テキサス・インスツルメンツ製品を使用する設計の経験を積んだ開発者への提供を意図したものです。(1) お客様のアプリケーションに適したテキサス・インスツルメンツ製品の選定、(2) お客様のアプリケーションの設計、検証、試験、(3) お客様のアプリケーションに該当する各種規格や、その他のあらゆる安全性、セキュリティ、規制、または他の要件への確実な適合に関する責任を、お客様のみが単独で負うものとし、ます。

上記の各種リソースは、予告なく変更される可能性があります。これらのリソースは、リソースで説明されているテキサス・インスツルメンツ製品を使用するアプリケーションの開発の目的でのみ、テキサス・インスツルメンツはその使用をお客様に許諾します。これらのリソースに関して、他の目的で複製することや掲載することは禁止されています。テキサス・インスツルメンツや第三者の知的財産権のライセンスが付与されている訳ではありません。お客様は、これらのリソースを自身で使用した結果発生するあらゆる申し立て、損害、費用、損失、責任について、テキサス・インスツルメンツおよびその代理人を完全に補償するものとし、テキサス・インスツルメンツは一切の責任を拒否します。

テキサス・インスツルメンツの製品は、[テキサス・インスツルメンツの販売条件](#)、または [ti.com](https://www.ti.com) やかかるテキサス・インスツルメンツ製品の関連資料などのいずれかを通じて提供する適用可能な条項の下で提供されています。テキサス・インスツルメンツがこれらのリソースを提供することは、適用されるテキサス・インスツルメンツの保証または他の保証の放棄の拡大や変更を意味するものではありません。

お客様がいかなる追加条項または代替条項を提案した場合でも、テキサス・インスツルメンツはそれらに異議を唱え、拒否します。

郵送先住所：Texas Instruments, Post Office Box 655303, Dallas, Texas 75265
Copyright © 2025, Texas Instruments Incorporated