

## SN74AHC1G14 シングル・シュミット・トリガ・インバータ・ゲート

### 1 特長

- 動作範囲：2V～5.5V
- 最大  $t_{pd}$  10ns (5V 時)
- 低消費電力、最大  $I_{CC}$  10 $\mu$ A
- $\pm 8$ mA の出力駆動能力 (5V 時)
- JESD 17 準拠で 250mA 超のラッチアップ性能

### 2 アプリケーション

- バーコード・スキャナ
- ケーブル・ソリューション
- eBook (電子書籍)
- 組み込み用 PC
- フィールド・トランスミッタ：温度センサ、圧力センサ
- 指紋認証
- HVAC：暖房、換気、空調
- ネットワーク接続ストレージ (NAS)
- サーバーのマザーボードおよび PSU
- ソフトウェア定義無線 (SDR)
- テレビ：高解像度 (HDTV)、LCD、デジタル
- ビデオ通信システム
- ワイヤレス・データ・アクセス・カード、ヘッドセット、キーボード、マウス、LAN カード

### 3 概要

SN74AHC1G14 デバイスはシングル・インバータ・ゲートです。このデバイスは、ブール関数  $Y = \bar{A}$  を実行します。

#### パッケージ情報

| 部品番号        | パッケージ <sup>(1)</sup> | パッケージ・サイズ <sup>(2)</sup> | 本体サイズ <sup>(3)</sup> |
|-------------|----------------------|--------------------------|----------------------|
| SN74AHC1G14 | DBV (SOT-23、5)       | 2.8mm × 2.8mm            | 2.9mm × 1.6mm        |
|             | DCK (SC-70、5)        | 2mm × 2.1mm              | 2mm × 1.25mm         |
|             | DRL (SOT-553、5)      | 1.6mm × 1.6mm            | 1.6mm × 1.2mm        |

- 利用可能なすべてのパッケージについては、データシートの末尾にある注文情報を参照してください。
- パッケージ・サイズ (長さ×幅) は公称値であり、該当する場合はピンも含まれます。
- 本体サイズ (長さ×幅) は公称値であり、ピンは含まれません。

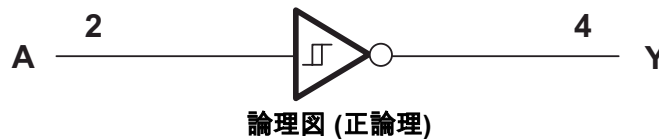

## Table of Contents

|   |   |  |    |
|---|---|--|----|
| <b>1 特長</b> .....   | 1 | 7.2 Functional Block Diagram.....                                | 8  |
| <b>2 アプリケーション</b> .....   | 1 | 7.3 Feature Description.....                                     | 8  |
| <b>3 概要</b> .....   | 1 | 7.4 Device Functional Modes.....                                 | 8  |
| <b>4 Pin Configuration and Functions</b> .....                                | 3 | <b>8 Application and Implementation</b> .....                    | 9  |
| <b>5 Specifications</b> .....   | 4 | 8.1 Application Information.....                                 | 9  |
| 5.1 Absolute Maximum Ratings.....   | 4 | 8.2 Typical Application.....                                     | 9  |
| 5.2 ESD Ratings.....  | 4 | 8.3 Power Supply Recommendations.....                            | 10 |
| 5.3 Recommended Operating Conditions.....                                     | 4 | 8.4 Layout.....  | 10 |
| 5.4 Thermal Information.....  | 5 | <b>9 Device and Documentation Support</b> .....                  | 12 |
| 5.5 Electrical Characteristics.....   | 5 | 9.1 Documentation Support (Analog).....                          | 12 |
| 5.6 Switching Characteristics, $V_{CC} = 3.3\text{ V} \pm 0.3\text{ V}$ ..... | 6 | 9.2 サポート・リソース.....   | 12 |
| 5.7 Switching Characteristics, $V_{CC} = 5\text{ V} \pm 0.5\text{ V}$ .....   | 6 | 9.3 Trademarks.....  | 12 |
| 5.8 Operating Characteristics.....  | 6 | 9.4 静電気放電に関する注意事項.....   | 12 |
| 5.9 Typical Characteristics.....  | 6 | 9.5 用語集.....   | 12 |
| <b>6 Parameter Measurement Information</b> .....                              | 7 | <b>10 Revision History</b> .....                                 | 12 |
| <b>7 Detailed Description</b> .....   | 8 | <b>11 Mechanical, Packaging, and Orderable Information</b> ..... | 12 |
| 7.1 Overview.....   | 8 |  |    |

## 4 Pin Configuration and Functions



図 4-1. DBV Package 5-Pin SOT-23 Top View



図 4-2. DCK Package 5-Pin SC70 Top View

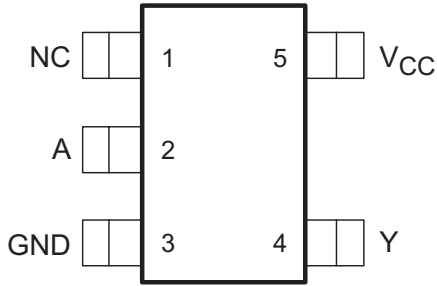

図 4-3. DRL Package 5-Pin SOT Top View

表 4-1. Pin Functions

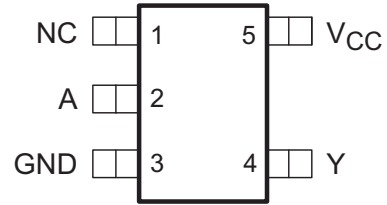
| PIN |      | TYPE <sup>(1)</sup> | DESCRIPTION |
|-----|------|---------------------|-------------|
| NO. | NAME |                     |             |
| 1   | NC   | —                   | No connect  |
| 2   | A    | I                   | Data Input  |
| 3   | GND  | —                   | Ground      |
| 4   | Y    | O                   | Data Output |
| 5   | VCC  | —                   | Power       |

(1) Signal Types: I = Input, O = Output, I/O = Input or Output

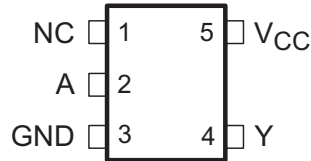
## 5 Specifications

### 5.1 Absolute Maximum Ratings

over operating free-air temperature range (unless otherwise noted)<sup>(1)</sup>

|                  |   |  | MIN  | MAX                   | UNIT |
|------------------|---|--|------|-----------------------|------|
| V <sub>CC</sub>  | Supply voltage                                    |  | -0.5 | 7                     | V    |
| V <sub>I</sub>   | Input voltage <sup>(2)</sup>                      |  | -0.5 | 7                     | V    |
| V <sub>O</sub>   | Output voltage <sup>(2)</sup>                     |  | -0.5 | V <sub>CC</sub> + 0.5 | V    |
| I <sub>IK</sub>  | Input clamp current                               | V <sub>I</sub> < 0                                     |      | -20                   | mA   |
| I <sub>OK</sub>  | Output clamp current                              | V <sub>O</sub> < 0 or V <sub>O</sub> > V <sub>CC</sub> |      | ±20                   | mA   |
| I <sub>O</sub>   | Continuous output current                         | V <sub>O</sub> = 0 to V <sub>CC</sub>                  |      | ±25                   | mA   |
|                  | Continuous current through V <sub>CC</sub> or GND |  |      | ±50                   | mA   |
| T <sub>J</sub>   | Maximum junction temperature                      |  |      | 150                   | °C   |
| T <sub>stg</sub> | Storage temperature                               |  | -65  | 150                   | °C   |

- (1) Stresses beyond those listed under *Absolute Maximum Ratings* may cause permanent damage to the device. These are stress ratings only, and functional operation of the device at these or any other conditions beyond those indicated under *Recommended Operating Conditions* is not implied. Exposure to absolute-maximum-rated conditions for extended periods may affect device reliability.
- (2) The input and output voltage ratings may be exceeded if the input and output current ratings are observed.

### 5.2 ESD Ratings

|                    |                         |  | VALUE | UNIT |
|--------------------|-------------------------|--|-------|------|
| V <sub>(ESD)</sub> | Electrostatic discharge | Human body model (HBM), per ANSI/ESDA/JEDEC JS-001, all pins <sup>(1)</sup>              | ±1500 | V    |
|                    |                         | Charged-device model (CDM), per JEDEC specification JESD22-C101, all pins <sup>(2)</sup> | ±1000 |      |

- (1) JEDEC document JEP155 states that 500-V HBM allows safe manufacturing with a standard ESD control process.
- (2) JEDEC document JEP157 states that 250-V CDM allows safe manufacturing with a standard ESD control process.

### 5.3 Recommended Operating Conditions

over operating free-air temperature range (unless otherwise noted)<sup>(1)</sup>

|                 |                                |                                 | MIN | MAX             | UNIT |
|-----------------|--------------------------------|---------------------------------|-----|-----------------|------|
| V <sub>CC</sub> | Supply voltage                 |                                 | 2   | 5.5             | V    |
| V <sub>I</sub>  | Input voltage                  |                                 | 0   | 5.5             | V    |
| V <sub>O</sub>  | Output voltage                 |                                 | 0   | V <sub>CC</sub> | V    |
| I <sub>OH</sub> | High-level output current      | V <sub>CC</sub> = 2 V           |     | -50             | μA   |
|                 |                                | V <sub>CC</sub> = 3.3 V ± 0.3 V |     | -4              | mA   |
|                 |                                | V <sub>CC</sub> = 5 V ± 0.5 V   |     | -8              |      |
| I <sub>OL</sub> | Low-level output current       | V <sub>CC</sub> = 2 V           |     | 50              | μA   |
|                 |                                | V <sub>CC</sub> = 3.3 V ± 0.3 V |     | 4               | mA   |
|                 |                                | V <sub>CC</sub> = 5 V ± 0.5 V   |     | 8               |      |
| T <sub>A</sub>  | Operating free-air temperature |                                 | -40 | 125             | °C   |

- (1) All unused inputs of the device must be held at V<sub>CC</sub> or GND to ensure proper device operation. Refer to the TI application report, *Implications of Slow or Floating CMOS Inputs*, [SCBA004](#).

## 5.4 Thermal Information

| THERMAL METRIC <sup>(1)</sup> |  | SN74AHC1G14  |            |           | UNIT |
|-------------------------------|--|--------------|------------|-----------|------|
|                               |  | DBV (SOT-23) | DCK (SC70) | DRL (SOT) |      |
|                               |  | 5 PINS       | 5 PINS     | 5 PINS    |      |
| R <sub>θJA</sub>              | Junction-to-ambient thermal resistance       | 278          | 289.2      | 271.8     | °C/W |
| R <sub>θJC(top)</sub>         | Junction-to-case (top) thermal resistance    | 180.5        | 205.8      | 116.6     | °C/W |
| R <sub>θJB</sub>              | Junction-to-board thermal resistance         | 184.4        | 176.2      | 89.9      | °C/W |
| ψ <sub>JT</sub>               | Junction-to-top characterization parameter   | 115.4        | 117.6      | 17.3      | °C/W |
| ψ <sub>JB</sub>               | Junction-to-board characterization parameter | 183.4        | 175.1      | 89.4      | °C/W |
| R <sub>θJC(bot)</sub>         | Junction-to-case (bot) thermal resistance    | N/A          | N/A        | N/A       | °C/W |

(1) For more information about traditional and new thermal metrics, see the *Semiconductor and IC Package Thermal Metrics* application report, [SPRA953](#).

## 5.5 Electrical Characteristics

over operating free-air temperature range (unless otherwise noted)

| PARAMETER       | TEST CONDITIONS                                 | V <sub>CC</sub>   | T <sub>A</sub> = 25°C |      |      | T <sub>A</sub> = –40°C to 85°C |      |      | RECOMMENDED<br>T <sub>A</sub> = –40°C to 125°C |      |      | UNIT |
|-----------------|---|---|-----------------------|------|------|--------------------------------|------|------|--|------|------|------|
|                 |   |   | MIN                   | TYP  | MAX  | MIN                            | TYP  | MAX  | MIN  | TYP  | MAX  |      |
| V <sub>T+</sub> | Positive-going input threshold voltage          | 3 V   | 1.2                   |      | 2.2  | 1.2                            |      | 2.2  | 1.2  |      | 2.2  | V    |
|                 |   | 4.5 V   | 1.75                  |      | 3.15 | 1.75                           |      | 3.15 | 1.75   |      | 3.15 |      |
|                 |   | 5.5 V   | 2.15                  |      | 3.85 | 2.15                           |      | 2.85 | 2.15   |      | 3.85 |      |
| V <sub>T–</sub> | Negative-going input threshold voltage          | 3 V   | 0.9                   |      | 1.9  | 0.9                            |      | 1.9  | 0.9  |      | 1.9  | V    |
|                 |   | 4.5 V   | 1.35                  |      | 2.75 | 1.35                           |      | 2.75 | 1.35   |      | 2.75 |      |
|                 |   | 5.5 V   | 1.65                  |      | 3.35 | 1.65                           |      | 3.35 | 1.65   |      | 3.35 |      |
| ΔV <sub>T</sub> | Hysteresis (V <sub>T+</sub> – V <sub>T–</sub> ) | 3 V   | 0.3                   |      | 1.2  | 0.3                            |      | 1.2  | 0.25   |      | 1.2  | V    |
|                 |   | 4.5 V   | 0.4                   |      | 1.4  | 0.4                            |      | 1.4  | 0.35   |      | 1.4  |      |
|                 |   | 5.5 V   | 0.5                   |      | 1.6  | 0.5                            |      | 1.6  | 0.45   |      | 1.6  |      |
| V <sub>OH</sub> | High level output voltage                       | I <sub>OH</sub> = –50 μA                                    | 2 V                   | 1.9  | 2    |                                | 1.9  |      |  | 1.9  |      | V    |
|                 |   |   | 3 V                   | 2.9  | 3    |                                | 2.9  |      |  | 2.9  |      |      |
|                 |   |   | 4.5 V                 | 4.4  | 4.5  |                                | 4.4  |      |  | 4.4  |      |      |
|                 |   | I <sub>OH</sub> = –4 mA                                     | 3 V                   | 2.58 |      |                                | 2.48 |      |  | 2.4  |      |      |
|                 |   | I <sub>OL</sub> = –8 mA                                     | 4.5 V                 | 3.94 |      |                                | 3.8  |      |  | 3.7  |      |      |
| V <sub>OL</sub> | Low level output voltage                        | I <sub>OH</sub> = 50 μA                                     | 2 V                   |      |      | 0.1                            |      |      | 0.1  |      | 0.1  | V    |
|                 |   |   | 3 V                   |      |      | 0.1                            |      |      | 0.1  |      | 0.1  |      |
|                 |   |   | 4.5 V                 |      |      | 0.1                            |      |      | 0.1  |      | 0.1  |      |
|                 |   | I <sub>OH</sub> = 4 mA                                      | 3 V                   |      |      | 0.36                           |      |      | 0.44   |      | 0.55 |      |
|                 |   | I <sub>OL</sub> = 8 mA                                      | 4.5 V                 |      |      | 0.36                           |      |      | 0.44   |      | 0.55 |      |
| I <sub>I</sub>  | Input leakage current                           | V <sub>I</sub> = 5.5 V or GND                               | 0 V to 5.5 V          |      |      |                                |      |      |  | ±0.1 | ±1   | μA   |
| I <sub>CC</sub> | Supply current                                  | V <sub>I</sub> = V <sub>CC</sub> or GND, I <sub>O</sub> = 0 | 5.5 V                 |      |      |                                |      |      |  | 1    | 10   | μA   |
| C <sub>i</sub>  | Input Capacitance                               | V <sub>I</sub> = V <sub>CC</sub> or GND                     | 5 V                   |      | 2    | 10                             |      |      |  |      | 10   | pF   |

## 5.6 Switching Characteristics, $V_{CC} = 3.3\text{ V} \pm 0.3\text{ V}$

over recommended operating free-air temperature range (unless otherwise noted) (see [Load Circuit and Voltage Waveforms](#))

| PARAMETER | FROM (INPUT) | TO (OUTPUT) | OUTPUT CAPACITANCE   | $T_A = 25^\circ\text{C}$ |      | $T_A = -40^\circ\text{C to } 85^\circ\text{C}$ |      | RECOMMENDED $T_A = -40^\circ\text{C to } 125^\circ\text{C}$ |      | UNIT |
|-----------|--------------|-------------|----------------------|--------------------------|------|--|------|---|------|------|
|           |              |             |                      | TYP                      | MAX  | MIN  | MAX  | MIN   | MAX  |      |
| $t_{PLH}$ | A            | Y           | $C_L = 15\text{ pF}$ | 8.3                      | 12.8 | 1  | 15   | 1   | 16   | ns   |
| $t_{PHL}$ |              |             |                      | 8.3                      | 12.8 | 1  | 15   | 1   | 16   | ns   |
| $t_{PLH}$ | A            | Y           | $C_L = 50\text{ pF}$ | 10.8                     | 16.3 | 1  | 18.5 | 1   | 19.5 | ns   |
| $t_{PHL}$ |              |             |                      | 10.8                     | 16.3 | 1  | 18.5 | 1   | 19.5 | ns   |

## 5.7 Switching Characteristics, $V_{CC} = 5\text{ V} \pm 0.5\text{ V}$

over recommended operating free-air temperature range (unless otherwise noted) (see [Load Circuit and Voltage Waveforms](#))

| PARAMETER | FROM (INPUT) | TO (OUTPUT) | OUTPUT CAPACITANCE   | $T_A = 25^\circ\text{C}$ |      | $T_A = -40^\circ\text{C to } 85^\circ\text{C}$ |     | RECOMMENDED $T_A = -40^\circ\text{C to } 125^\circ\text{C}$ |     | UNIT |
|-----------|--------------|-------------|----------------------|--------------------------|------|--|-----|---|-----|------|
|           |              |             |                      | TYP                      | MAX  | MIN  | MAX | MIN   | MAX |      |
| $t_{PLH}$ | A or B       | Y           | $C_L = 15\text{ pF}$ | 5.5                      | 8.6  | 1  | 10  | 1   | 11  | ns   |
| $t_{PHL}$ |              |             |                      | 5.5                      | 8.6  | 1  | 10  | 1   | 11  | ns   |
| $t_{PLH}$ | A or B       | Y           | $C_L = 50\text{ pF}$ | 7                        | 10.6 | 1  | 12  | 1   | 11  | ns   |
| $t_{PHL}$ |              |             |                      | 7                        | 10.6 | 1  | 12  | 1   | 11  | ns   |

## 5.8 Operating Characteristics

$V_{CC} = 5\text{ V}$ ,  $T_A = 25^\circ\text{C}$

| PARAMETER                              | TEST CONDITIONS             | TYP | UNIT |
|--|-----------------------------|-----|------|
| $C_{pd}$ Power dissipation capacitance | No load, $f = 1\text{ MHz}$ | 9   | pF   |

## 5.9 Typical Characteristics

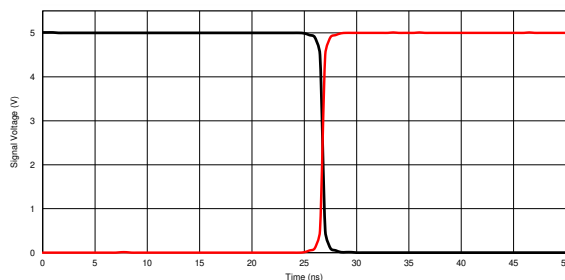

$T_A = 25^\circ\text{C}$ ,  $V_A = 5\text{ V}$

图 5-1. Response Time vs Output Voltage

## 6 Parameter Measurement Information

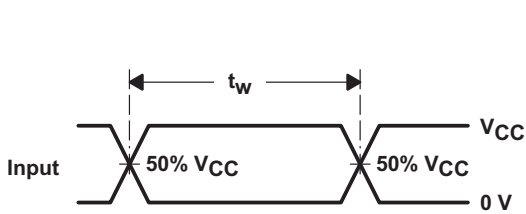
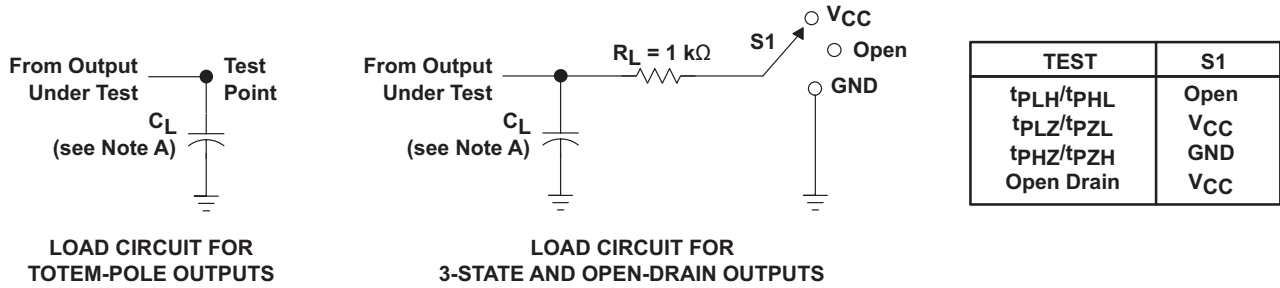

VOLTAGE WAVEFORMS  
PULSE DURATION

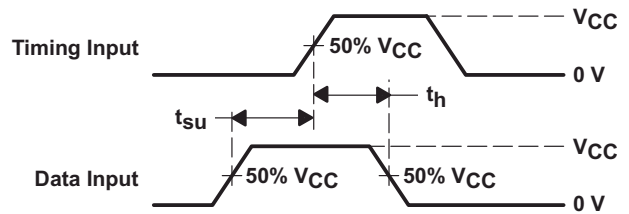

VOLTAGE WAVEFORMS  
SETUP AND HOLD TIMES

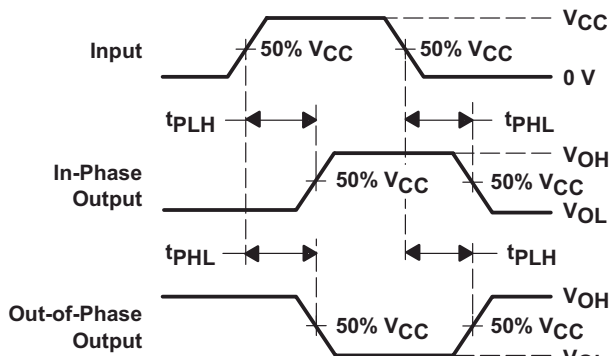

VOLTAGE WAVEFORMS  
PROPAGATION DELAY TIMES  
INVERTING AND NONINVERTING OUTPUTS

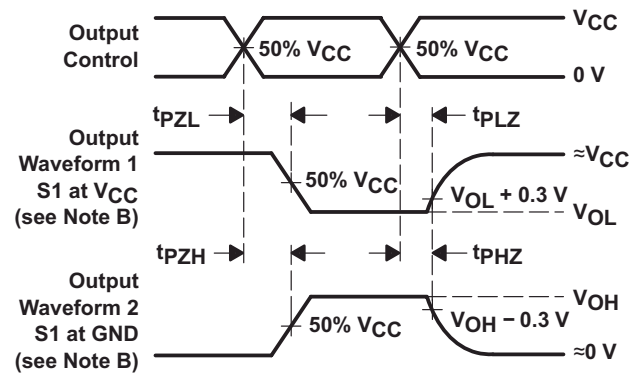

VOLTAGE WAVEFORMS  
ENABLE AND DISABLE TIMES  
LOW- AND HIGH-LEVEL ENABLING

- $C_L$  includes probe and jig capacitance.
- Waveform 1 is for an output with internal conditions such that the output is low except when disabled by the output control. Waveform 2 is for an output with internal conditions such that the output is high except when disabled by the output control.
- All input pulses are supplied by generators having the following characteristics:  $PRR \leq 1\text{ MHz}$ ,  $Z_O = 50\ \Omega$ ,  $t_r \leq 3\text{ ns}$ ,  $t_f \leq 3\text{ ns}$ .
- The outputs are measured one at a time with one input transition per measurement.
- All parameters and waveforms are not applicable to all devices.

图 6-1. Load Circuit and Voltage Waveforms

## 7 Detailed Description

### 7.1 Overview

The SN74AHC1G14 device is a single inverter gate. The device performs the Boolean function  $Y = \bar{A}$ .

The device functions as an independent inverter gate, but because of the Schmitt action, gates may have different input threshold levels for positive- ( $V_{T+}$ ) and negative-going ( $V_{T-}$ ) signals.

### 7.2 Functional Block Diagram



図 7-1. Logic Diagram (Positive Side)

### 7.3 Feature Description

The SN74AHC1G14 device has a wide operating  $V_{CC}$  range of 2 V to 5.5 V, which allows it to be used in a broad range of systems. The low propagation delay allows fast switching and higher speeds of operation. In addition, the low-power consumption makes this device a good choice for portable and battery power-sensitive applications.

### 7.4 Device Functional Modes

表 7-1 lists the functional modes for SN74AHC1G14.

表 7-1. Function Table

| INPUT <sup>(1)</sup> A | OUTPUT <sup>(2)</sup> Y |
|------------------------|-------------------------|
| H                      | L                       |
| L                      | H                       |

- (1) H = High Voltage Level, L = Low Voltage Level, X = Don't Care
- (2) H = Driving High, L = Driving Low, Z = High Impedance State



## 8 Application and Implementation

### 注

以下のアプリケーション情報は、TI の製品仕様に含まれるものではなく、TI ではその正確性または完全性を保証いたしません。個々の目的に対する製品の適合性については、お客様の責任で判断していただくことになります。お客様は自身の設計実装を検証しテストすることで、システムの機能を確認する必要があります。

### 8.1 Application Information

Physically interactive interface elements like push buttons or rotary knobs offer simple and easy ways to interact with an electronic system. Many of these physical interface elements often have issues with bouncing, or where the physical conductive contact can connect and disconnect multiple times during a button push or release. This bouncing can cause one or more faulty transient signals to be passed during this transitional period. These faulty signals can be observed in many common applications, for example, a television remote with bouncing error can adjust the TV channel multiple times despite the button being pushed only once. To mitigate these faulty signals, we can use a Schmitt-trigger, or a device with hysteresis, to remove these faulty signals. Hysteresis allows a device to *remember* its history, and in this case, the SN74AHC1G14 uses this memory to debounce the signal of the physical element, or filter the faulty transient signals and pass only the valid signal each time the element is used. In this example, we show a push-button signal passed through an SN74AHC1G14 that is debounced and inverted to the microprocessor for push detection.

### 8.2 Typical Application



図 8-1. Switch Debouncer

#### 8.2.1 Design Requirements

The SN74AHC1G14 device uses CMOS technology and has balanced output drive. Take care to avoid bus contention because it can drive currents that would exceed maximum limits. The SN74AHC1G14 allows for performing logical Boolean functions with hysteresis using digital signals. All input signals must remain as close as possible to either 0 V or VCC for optimal operation.

## 8.2.2 Detailed Design Procedure

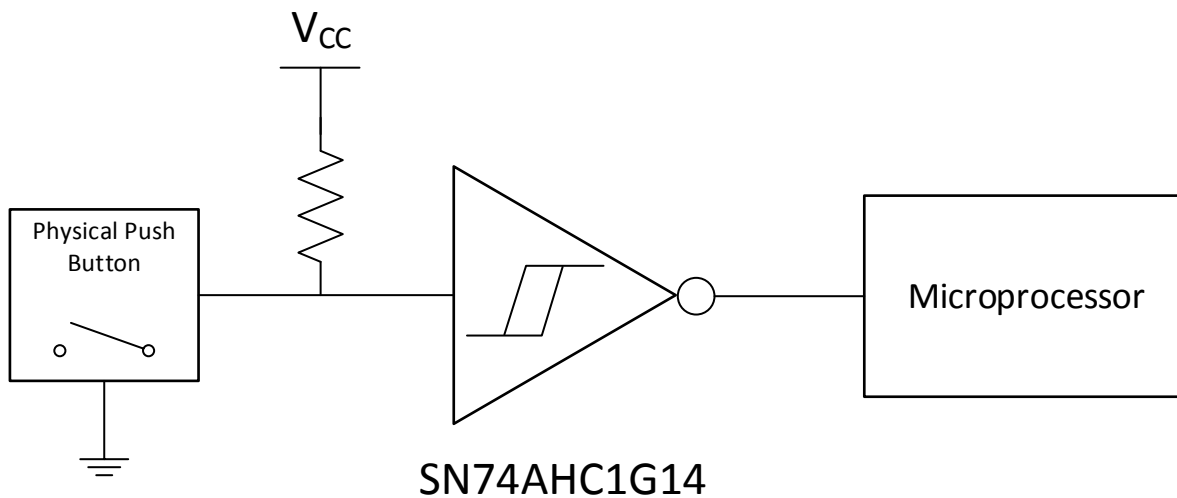
- Recommended input conditions:
  - For rise time and fall time specifications, see  $\Delta t/\Delta v$  in the [セクション 5.3](#) table.
  - For specified high and low levels, see  $V_{IH}$  and  $V_{IL}$  in the [セクション 5.3](#) table.
  - Inputs and outputs are overvoltage tolerant and can therefore go as high as 5.5 V at any valid  $V_{CC}$ .
- Recommended output conditions:
  - Load currents must not exceed  $\pm 50$  mA.
- Frequency selection criterion:
  - The effects of frequency upon the power consumption of the device can be studied in *CMOS Power Consumption and CPD Calculation*, [SCAA035](#).
  - Added trace resistance and capacitance can reduce maximum frequency capability; follow the layout practices listed in the [セクション 8.4.1](#) section.

## 8.2.3 Application Curves

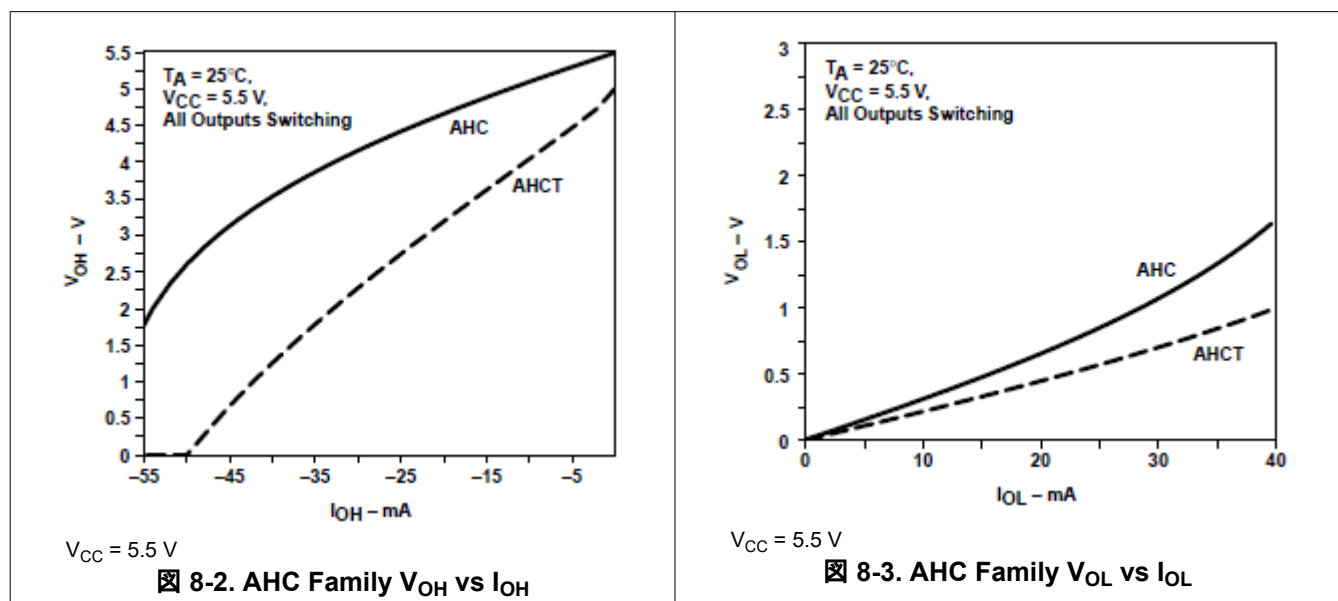

## 8.3 Power Supply Recommendations

The power supply can be any voltage between the minimum and maximum supply voltage rating listed in the [セクション 5.3](#) table.

Each  $V_{CC}$  terminal must have a good bypass capacitor to prevent power disturbance. For devices with a single supply, a 0.1- $\mu$ F bypass capacitor is recommended. If multiple pins are labeled  $V_{CC}$ , then a 0.01- $\mu$ F or 0.022- $\mu$ F capacitor is recommended for each  $V_{CC}$  because the  $V_{CC}$  pins are tied together internally. For devices with dual-supply pins operating at different voltages, for example  $V_{CC}$  and  $V_{DD}$ , a 0.1- $\mu$ F bypass capacitor is recommended for each supply pin. To reject different frequencies of noise, use multiple bypass capacitors in parallel. Capacitors with values of 0.1  $\mu$ F and 1  $\mu$ F are commonly used in parallel. The bypass capacitor must be installed as close as possible to the power terminal for best results.

## 8.4 Layout

### 8.4.1 Layout Guidelines

Reflections and matching are closely related to the loop antenna theory but are different enough to be discussed separately from the theory. When a PCB trace turns a corner at a 90° angle, a reflection can occur. A reflection occurs primarily because of the change of width of the trace. At the apex of the turn, the trace width increases to 1.414 times the width. This increase upsets the transmission-line characteristics, especially the distributed

capacitance and self-inductance of the trace, which results in the reflection. Not all PCB traces can be straight; therefore some traces must turn corners.  8-4 shows progressively better techniques of rounding corners. Only the last example (BEST) maintains constant trace width and minimizes reflections.

#### 8.4.1.1 Layout Example

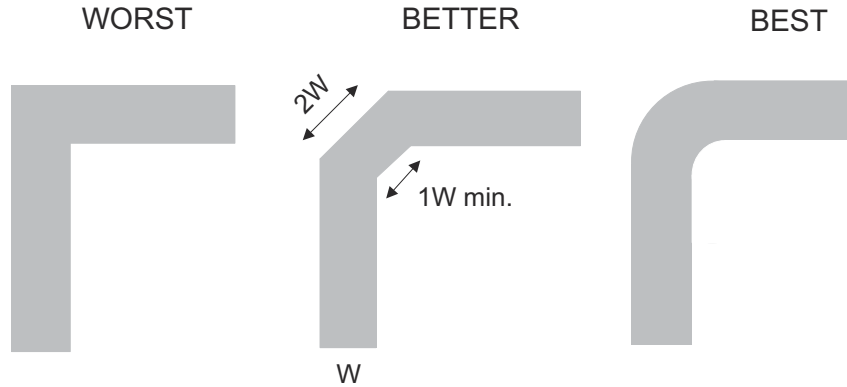

 8-4. Trace Example

## 9 Device and Documentation Support

### 9.1 Documentation Support (Analog)

#### 9.1.1 Related Documentation

For related documentation see the following:

- *Implications of Slow or Floating CMOS Inputs*, SCBA004
- *CMOS Power Consumption and CPD Calculation*, SCAA035
- *Selecting the Right Texas Instruments Signal Switch*, SZZA030

### 9.2 サポート・リソース

[テキサス・インスツルメンツ E2E™ サポート・フォーラム](#)は、エンジニアが検証済みの回答と設計に関するヒントをエキスパートから迅速かつ直接得ることができる場所です。既存の回答を検索したり、独自の質問をしたりすることで、設計に必要な支援を迅速に得ることができます。

リンクされているコンテンツは、各寄稿者により「現状のまま」提供されるものです。これらはテキサス・インスツルメンツの仕様を構成するものではなく、必ずしもテキサス・インスツルメンツの見解を反映したものではありません。テキサス・インスツルメンツの[使用条件](#)を参照してください。

### 9.3 Trademarks

テキサス・インスツルメンツ E2E™ is a trademark of Texas Instruments.

すべての商標は、それぞれの所有者に帰属します。

### 9.4 静電気放電に関する注意事項



この IC は、ESD によって破損する可能性があります。テキサス・インスツルメンツは、IC を取り扱う際には常に適切な注意を払うことを推奨します。正しい取り扱いおよび設置手順に従わない場合、デバイスを破損するおそれがあります。

ESD による破損は、わずかな性能低下からデバイスの完全な故障まで多岐にわたります。精密な IC の場合、パラメータがわずかに変化するだけで公表されている仕様から外れる可能性があるため、破損が発生しやすくなっています。

### 9.5 用語集

[テキサス・インスツルメンツ用語集](#) この用語集には、用語や略語の一覧および定義が記載されています。

## 10 Revision History

資料番号末尾の英字は改訂を表しています。その改訂履歴は英語版に準じています。

### Changes from Revision R (October 2023) to Revision S (February 2024) Page

- |  |   |
|--|---|
| • Updated thermal values for DBV package from RθJA = 225.7 to 278, RθJC(top) = 160.3 to 180.5, RθJB = 59.4 to 184.4, ΨJT = 41.0 to 115.4, ΨJB = 58.7 to 183.4, RθJC(bot) = N/A, all values in °C/W ..... | 5 |
|--|---|

### Changes from Revision Q (February 2014) to Revision R (October 2023) Page

- |  |   |
|--|---|
| • 文書全体にわたって表、図、相互参照の採番方法を更新.....   | 1 |
| • Updated thermal values for DCK package: RθJA = 287.6 to 289.2, all values in °C/W .....  | 5 |
| • Added thermal values for DCK package: RθJC(top) = 205.8, RθJB = 176.2, ΨJT = 117.6, ΨJB = 175.1, RθJC(bot) = N/A, all values in °C/W ..... | 5 |

## 11 Mechanical, Packaging, and Orderable Information

The following pages include mechanical packaging and orderable information. This information is the most current data available for the designated devices. This data is subject to change without notice and revision of this document. For browser based versions of this data sheet, refer to the left hand navigation.

**PACKAGING INFORMATION**

| Orderable Device  | Status<br>(1) | Package Type | Package Drawing | Pins | Package Qty | Eco Plan<br>(2)  | Lead finish/<br>Ball material<br>(6) | MSL Peak Temp<br>(3) | Op Temp (°C) | Device Marking<br>(4/5)        | Samples                 |
|-------------------|---------------|--------------|-----------------|------|-------------|------------------|--------------------------------------|----------------------|--------------|--------------------------------|-------------------------|
| SN74AHC1G14DBVR   | ACTIVE        | SOT-23       | DBV             | 5    | 3000        | RoHS & Green     | NIPDAU   SN                          | Level-1-260C-UNLIM   | -40 to 125   | (A143, A14G, A14J, A14L, A14S) | <a href="#">Samples</a> |
| SN74AHC1G14DBVRE4 | ACTIVE        | SOT-23       | DBV             | 5    | 3000        | RoHS & Green     | NIPDAU                               | Level-1-260C-UNLIM   | -40 to 125   | A14G                           | <a href="#">Samples</a> |
| SN74AHC1G14DBVRG4 | ACTIVE        | SOT-23       | DBV             | 5    | 3000        | RoHS & Green     | NIPDAU                               | Level-1-260C-UNLIM   | -40 to 125   | A14G                           | <a href="#">Samples</a> |
| SN74AHC1G14DBVT   | OBSOLETE      | SOT-23       | DBV             | 5    |             | TBD              | Call TI                              | Call TI              | -40 to 125   | (A143, A14G, A14J, A14S)       |                         |
| SN74AHC1G14DCK3   | ACTIVE        | SC70         | DCK             | 5    | 3000        | RoHS & Non-Green | SNBI                                 | Level-1-260C-UNLIM   | -40 to 125   | AFY                            | <a href="#">Samples</a> |
| SN74AHC1G14DCKR   | ACTIVE        | SC70         | DCK             | 5    | 3000        | RoHS & Green     | NIPDAU   SN                          | Level-1-260C-UNLIM   | -40 to 125   | (AF3, AFG, AFJ, AFL, AFS)      | <a href="#">Samples</a> |
| SN74AHC1G14DCKRG4 | ACTIVE        | SC70         | DCK             | 5    | 3000        | RoHS & Green     | NIPDAU                               | Level-1-260C-UNLIM   | -40 to 125   | AF3                            | <a href="#">Samples</a> |
| SN74AHC1G14DCKT   | OBSOLETE      | SC70         | DCK             | 5    |             | TBD              | Call TI                              | Call TI              | -40 to 125   | (AF3, AFG, AFJ, AFS)           |                         |
| SN74AHC1G14DCKTE4 | ACTIVE        | SC70         | DCK             | 5    | 250         | RoHS & Green     | NIPDAU                               | Level-1-260C-UNLIM   | -40 to 125   | AF3                            | <a href="#">Samples</a> |
| SN74AHC1G14DCKTG4 | ACTIVE        | SC70         | DCK             | 5    | 250         | RoHS & Green     | NIPDAU                               | Level-1-260C-UNLIM   | -40 to 125   | AF3                            | <a href="#">Samples</a> |
| SN74AHC1G14DRLR   | ACTIVE        | SOT-5X3      | DRL             | 5    | 4000        | RoHS & Green     | NIPDAUAG                             | Level-1-260C-UNLIM   | -40 to 125   | AFS                            | <a href="#">Samples</a> |
| SN74AHC1G14DRLRG4 | ACTIVE        | SOT-5X3      | DRL             | 5    | 4000        | RoHS & Green     | NIPDAUAG                             | Level-1-260C-UNLIM   | -40 to 125   | AFS                            | <a href="#">Samples</a> |

(1) The marketing status values are defined as follows:

**ACTIVE:** Product device recommended for new designs.

**LIFEBUY:** TI has announced that the device will be discontinued, and a lifetime-buy period is in effect.

**NRND:** Not recommended for new designs. Device is in production to support existing customers, but TI does not recommend using this part in a new design.

**PREVIEW:** Device has been announced but is not in production. Samples may or may not be available.

**OBSOLETE:** TI has discontinued the production of the device.

(2) **RoHS:** TI defines "RoHS" to mean semiconductor products that are compliant with the current EU RoHS requirements for all 10 RoHS substances, including the requirement that RoHS substance do not exceed 0.1% by weight in homogeneous materials. Where designed to be soldered at high temperatures, "RoHS" products are suitable for use in specified lead-free processes. TI may reference these types of products as "Pb-Free".

**RoHS Exempt:** TI defines "RoHS Exempt" to mean products that contain lead but are compliant with EU RoHS pursuant to a specific EU RoHS exemption.

**Green:** TI defines "Green" to mean the content of Chlorine (Cl) and Bromine (Br) based flame retardants meet JS709B low halogen requirements of <=1000ppm threshold. Antimony trioxide based flame retardants must also meet the <=1000ppm threshold requirement.

(3) MSL, Peak Temp. - The Moisture Sensitivity Level rating according to the JEDEC industry standard classifications, and peak solder temperature.

(4) There may be additional marking, which relates to the logo, the lot trace code information, or the environmental category on the device.

(5) Multiple Device Markings will be inside parentheses. Only one Device Marking contained in parentheses and separated by a "~" will appear on a device. If a line is indented then it is a continuation of the previous line and the two combined represent the entire Device Marking for that device.

(6) Lead finish/Ball material - Orderable Devices may have multiple material finish options. Finish options are separated by a vertical ruled line. Lead finish/Ball material values may wrap to two lines if the finish value exceeds the maximum column width.

**Important Information and Disclaimer:**The information provided on this page represents TI's knowledge and belief as of the date that it is provided. TI bases its knowledge and belief on information provided by third parties, and makes no representation or warranty as to the accuracy of such information. Efforts are underway to better integrate information from third parties. TI has taken and continues to take reasonable steps to provide representative and accurate information but may not have conducted destructive testing or chemical analysis on incoming materials and chemicals. TI and TI suppliers consider certain information to be proprietary, and thus CAS numbers and other limited information may not be available for release.

In no event shall TI's liability arising out of such information exceed the total purchase price of the TI part(s) at issue in this document sold by TI to Customer on an annual basis.

**OTHER QUALIFIED VERSIONS OF SN74AHC1G14 :**

- Automotive : [SN74AHC1G14-Q1](#)

NOTE: Qualified Version Definitions:

- Automotive - Q100 devices qualified for high-reliability automotive applications targeting zero defects

**TAPE AND REEL INFORMATION**

**QUADRANT ASSIGNMENTS FOR PIN 1 ORIENTATION IN TAPE**

\*All dimensions are nominal

| Device            | Package Type | Package Drawing | Pins | SPQ  | Reel Diameter (mm) | Reel Width W1 (mm) | A0 (mm) | B0 (mm) | K0 (mm) | P1 (mm) | W (mm) | Pin1 Quadrant |
|-------------------|--------------|-----------------|------|------|--------------------|--------------------|---------|---------|---------|---------|--------|---------------|
| SN74AHC1G14DBVR   | SOT-23       | DBV             | 5    | 3000 | 178.0              | 9.0                | 3.3     | 3.2     | 1.4     | 4.0     | 8.0    | Q3            |
| SN74AHC1G14DBVR   | SOT-23       | DBV             | 5    | 3000 | 180.0              | 8.4                | 3.23    | 3.17    | 1.37    | 4.0     | 8.0    | Q3            |
| SN74AHC1G14DBVRG4 | SOT-23       | DBV             | 5    | 3000 | 178.0              | 9.0                | 3.23    | 3.17    | 1.37    | 4.0     | 8.0    | Q3            |
| SN74AHC1G14DCKR   | SC70         | DCK             | 5    | 3000 | 178.0              | 9.0                | 2.4     | 2.5     | 1.2     | 4.0     | 8.0    | Q3            |
| SN74AHC1G14DCKR   | SC70         | DCK             | 5    | 3000 | 180.0              | 8.4                | 2.47    | 2.3     | 1.25    | 4.0     | 8.0    | Q3            |
| SN74AHC1G14DCKRG4 | SC70         | DCK             | 5    | 3000 | 178.0              | 9.2                | 2.4     | 2.4     | 1.22    | 4.0     | 8.0    | Q3            |
| SN74AHC1G14DCKTG4 | SC70         | DCK             | 5    | 250  | 178.0              | 9.2                | 2.4     | 2.4     | 1.22    | 4.0     | 8.0    | Q3            |
| SN74AHC1G14DRLR   | SOT-5X3      | DRL             | 5    | 4000 | 180.0              | 8.4                | 1.98    | 1.78    | 0.69    | 4.0     | 8.0    | Q3            |

**TAPE AND REEL BOX DIMENSIONS**

\*All dimensions are nominal

| Device            | Package Type | Package Drawing | Pins | SPQ  | Length (mm) | Width (mm) | Height (mm) |
|-------------------|--------------|-----------------|------|------|-------------|------------|-------------|
| SN74AHC1G14DBVR   | SOT-23       | DBV             | 5    | 3000 | 180.0       | 180.0      | 18.0        |
| SN74AHC1G14DBVR   | SOT-23       | DBV             | 5    | 3000 | 202.0       | 201.0      | 28.0        |
| SN74AHC1G14DBVRG4 | SOT-23       | DBV             | 5    | 3000 | 180.0       | 180.0      | 18.0        |
| SN74AHC1G14DCKR   | SC70         | DCK             | 5    | 3000 | 180.0       | 180.0      | 18.0        |
| SN74AHC1G14DCKR   | SC70         | DCK             | 5    | 3000 | 202.0       | 201.0      | 28.0        |
| SN74AHC1G14DCKRG4 | SC70         | DCK             | 5    | 3000 | 180.0       | 180.0      | 18.0        |
| SN74AHC1G14DCKTG4 | SC70         | DCK             | 5    | 250  | 180.0       | 180.0      | 18.0        |
| SN74AHC1G14DRLR   | SOT-5X3      | DRL             | 5    | 4000 | 202.0       | 201.0      | 28.0        |



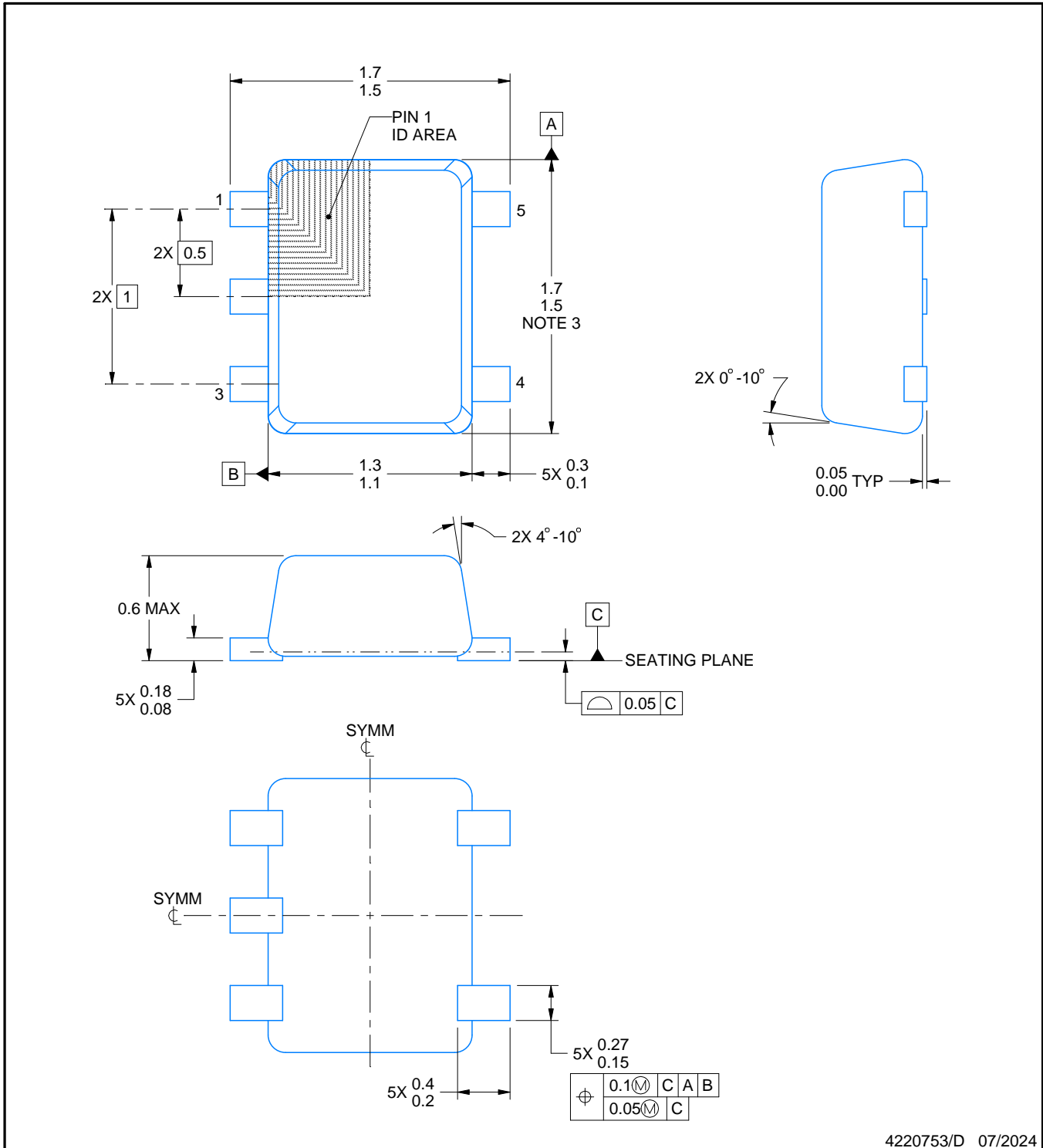
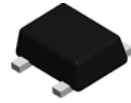

4220753/D 07/2024

NOTES:

1. All linear dimensions are in millimeters. Any dimensions in parenthesis are for reference only. Dimensioning and tolerancing per ASME Y14.5M.
2. This drawing is subject to change without notice.
3. This dimension does not include mold flash, protrusions, or gate burrs. Mold flash, protrusions, or gate burrs shall not exceed 0.15 mm per side.
4. Reference JEDEC registration MO-293 Variation UAAD-1

# EXAMPLE BOARD LAYOUT

DRL0005A

SOT - 0.6 mm max height

PLASTIC SMALL OUTLINE

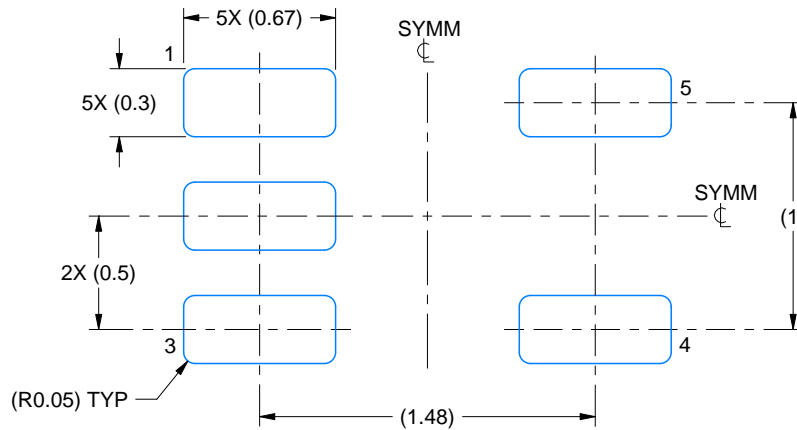

LAND PATTERN EXAMPLE  
SCALE:30X

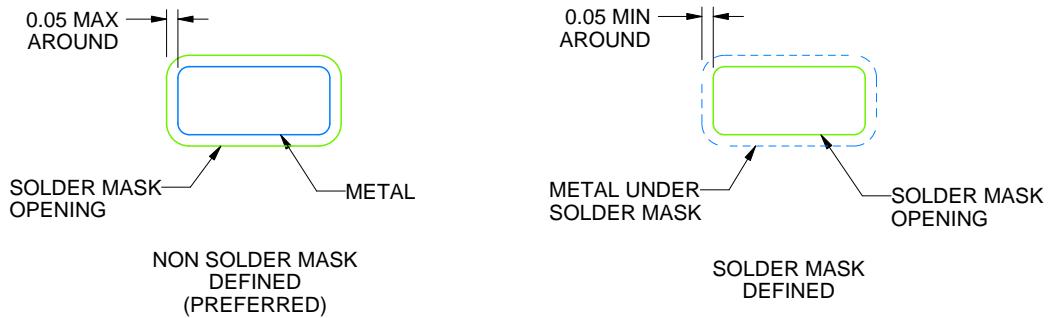

SOLDERMASK DETAILS

4220753/D 07/2024

NOTES: (continued)

- 5. Publication IPC-7351 may have alternate designs.
- 6. Solder mask tolerances between and around signal pads can vary based on board fabrication site.

# EXAMPLE STENCIL DESIGN

DRL0005A

SOT - 0.6 mm max height

PLASTIC SMALL OUTLINE

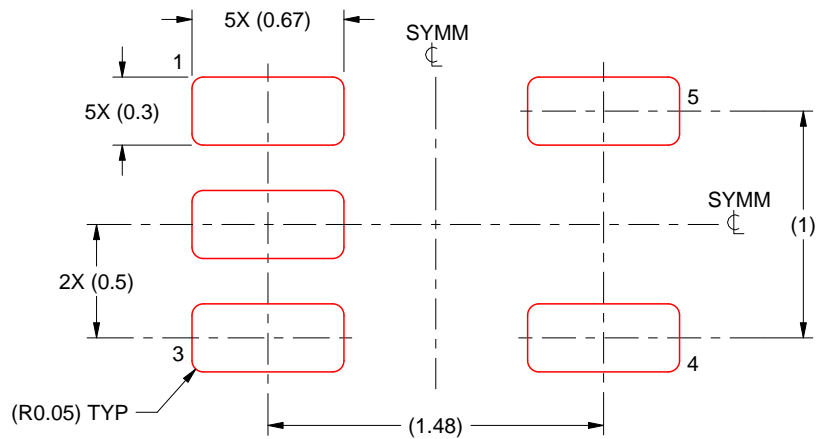

SOLDER PASTE EXAMPLE  
BASED ON 0.1 mm THICK STENCIL  
SCALE:30X

4220753/D 07/2024

NOTES: (continued)

7. Laser cutting apertures with trapezoidal walls and rounded corners may offer better paste release. IPC-7525 may have alternate design recommendations.
8. Board assembly site may have different recommendations for stencil design.

# DBV0005A



# PACKAGE OUTLINE

SOT-23 - 1.45 mm max height

SMALL OUTLINE TRANSISTOR

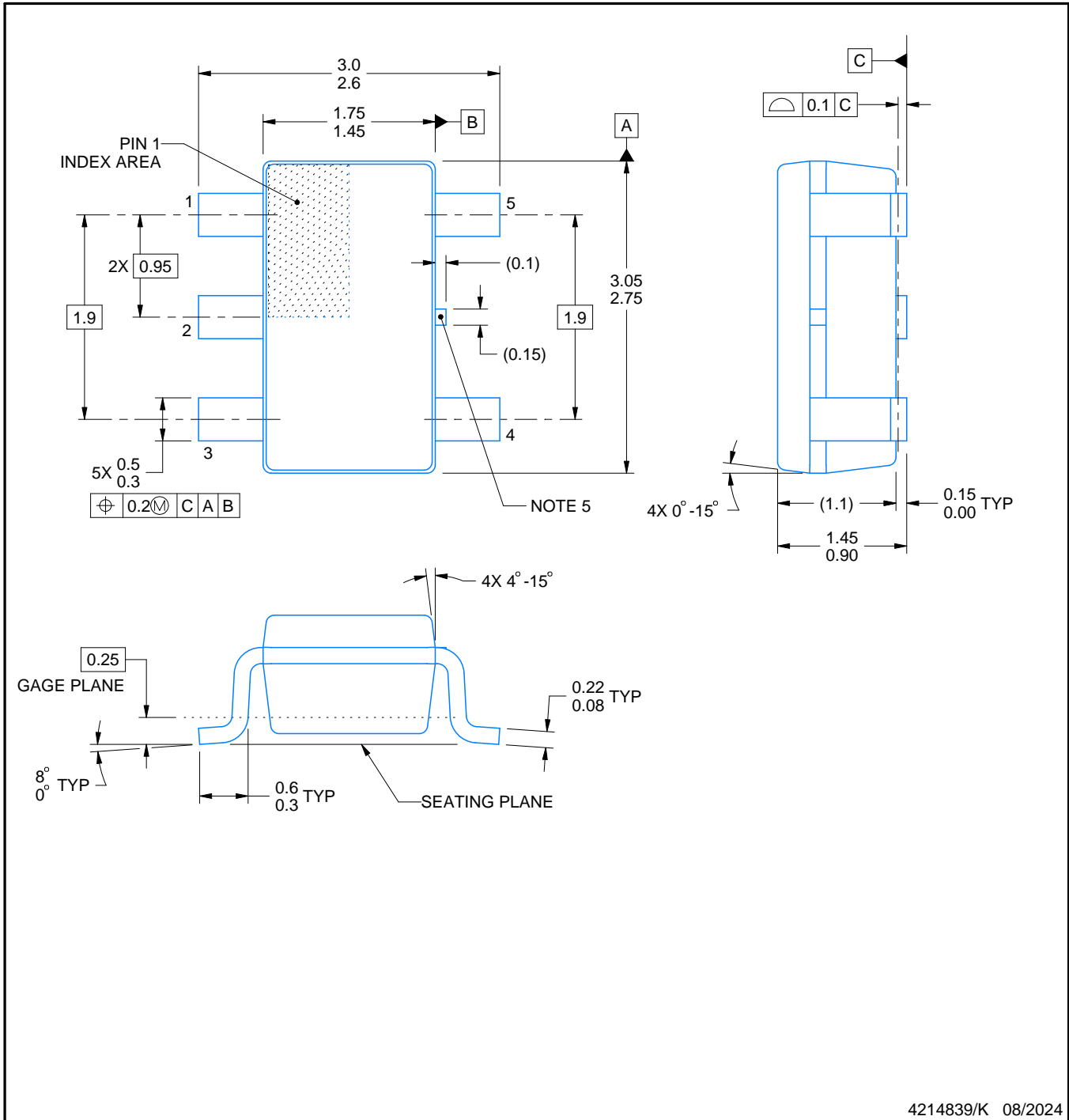

4214839/K 08/2024

**NOTES:**

- 1. All linear dimensions are in millimeters. Any dimensions in parenthesis are for reference only. Dimensioning and tolerancing per ASME Y14.5M.
- 2. This drawing is subject to change without notice.
- 3. Reference JEDEC MO-178.
- 4. Body dimensions do not include mold flash, protrusions, or gate burrs. Mold flash, protrusions, or gate burrs shall not exceed 0.25 mm per side.
- 5. Support pin may differ or may not be present.

# EXAMPLE BOARD LAYOUT

DBV0005A

SOT-23 - 1.45 mm max height

SMALL OUTLINE TRANSISTOR



LAND PATTERN EXAMPLE  
EXPOSED METAL SHOWN  
SCALE:15X



SOLDER MASK DETAILS

4214839/K 08/2024

NOTES: (continued)

- 6. Publication IPC-7351 may have alternate designs.
- 7. Solder mask tolerances between and around signal pads can vary based on board fabrication site.

# EXAMPLE STENCIL DESIGN

DBV0005A

SOT-23 - 1.45 mm max height

SMALL OUTLINE TRANSISTOR



SOLDER PASTE EXAMPLE  
BASED ON 0.125 mm THICK STENCIL  
SCALE:15X

4214839/K 08/2024

NOTES: (continued)

8. Laser cutting apertures with trapezoidal walls and rounded corners may offer better paste release. IPC-7525 may have alternate design recommendations.
9. Board assembly site may have different recommendations for stencil design.

# DCK0005A



# PACKAGE OUTLINE

SOT - 1.1 max height

SMALL OUTLINE TRANSISTOR

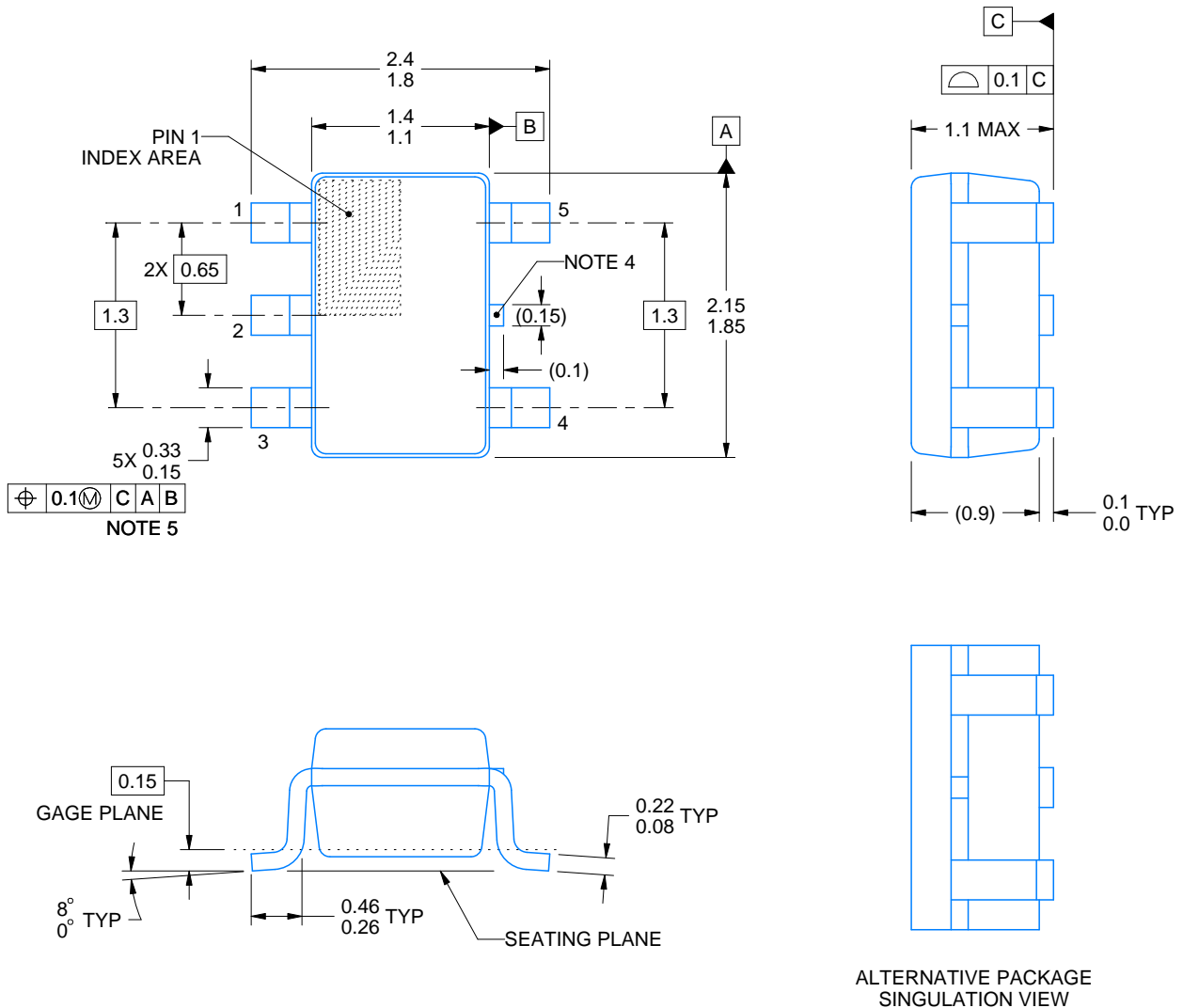

4214834/E 06/2024

**NOTES:**

1. All linear dimensions are in millimeters. Any dimensions in parenthesis are for reference only. Dimensioning and tolerancing per ASME Y14.5M.
2. This drawing is subject to change without notice.
3. Reference JEDEC MO-203.
4. Support pin may differ or may not be present.
5. Lead width does not comply with JEDEC.
6. Body dimensions do not include mold flash, protrusions, or gate burrs. Mold flash, protrusions, or gate burrs shall not exceed 0.25mm per side

# EXAMPLE BOARD LAYOUT

DCK0005A

SOT - 1.1 max height

SMALL OUTLINE TRANSISTOR



LAND PATTERN EXAMPLE  
EXPOSED METAL SHOWN  
SCALE:18X

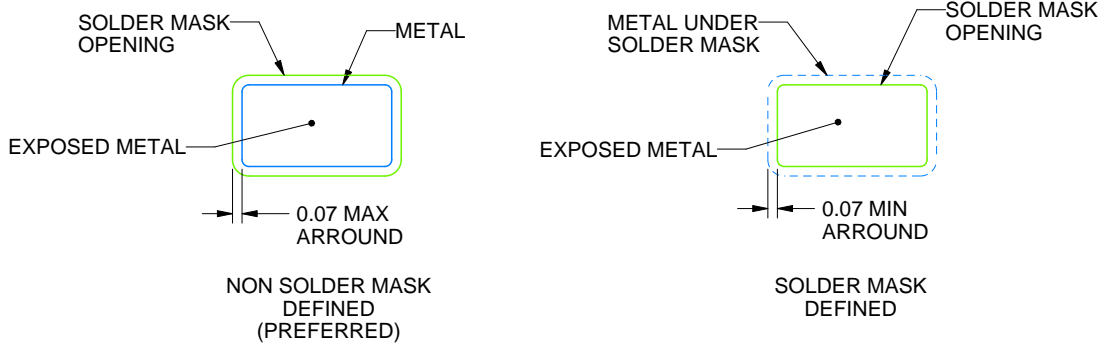

SOLDER MASK DETAILS

4214834/E 06/2024

NOTES: (continued)

- 7. Publication IPC-7351 may have alternate designs.
- 8. Solder mask tolerances between and around signal pads can vary based on board fabrication site.



# EXAMPLE STENCIL DESIGN

DCK0005A

SOT - 1.1 max height

SMALL OUTLINE TRANSISTOR



SOLDER PASTE EXAMPLE  
BASED ON 0.125 THICK STENCIL  
SCALE: 18X

4214834/E 06/2024

NOTES: (continued)

9. Laser cutting apertures with trapezoidal walls and rounded corners may offer better paste release. IPC-7525 may have alternate design recommendations.
10. Board assembly site may have different recommendations for stencil design.

## 重要なお知らせと免責事項

TI は、技術データと信頼性データ (データシートを含みます)、設計リソース (リファレンス・デザインを含みます)、アプリケーションや設計に関する各種アドバイス、Web ツール、安全性情報、その他のリソースを、欠陥が存在する可能性のある「現状のまま」提供しており、商品性および特定目的に対する適合性の黙示保証、第三者の知的財産権の非侵害保証を含むいかなる保証も、明示的または黙示的にかかわらず拒否します。

これらのリソースは、TI 製品を使用する設計の経験を積んだ開発者への提供を意図したものです。(1) お客様のアプリケーションに適した TI 製品の選定、(2) お客様のアプリケーションの設計、検証、試験、(3) お客様のアプリケーションに該当する各種規格や、その他のあらゆる安全性、セキュリティ、規制、または他の要件への確実な適合に関する責任を、お客様のみが単独で負うものとします。

上記の各種リソースは、予告なく変更される可能性があります。これらのリソースは、リソースで説明されている TI 製品を使用するアプリケーションの開発の目的でのみ、TI はその使用をお客様に許諾します。これらのリソースに関して、他の目的で複製することや掲載することは禁止されています。TI や第三者の知的財産権のライセンスが付与されている訳ではありません。お客様は、これらのリソースを自身で使用した結果発生するあらゆる申し立て、損害、費用、損失、責任について、TI およびその代理人を完全に補償するものとし、TI は一切の責任を拒否します。

TI の製品は、[TI の販売条件](#)、または [ti.com](#) やかかる TI 製品の関連資料などのいずれかを通じて提供する適用可能な条項の下で提供されています。TI がこれらのリソースを提供することは、適用される TI の保証または他の保証の放棄の拡大や変更を意味するものではありません。

お客様がいかなる追加条項または代替条項を提案した場合でも、TI はそれらに異議を唱え、拒否します。

郵送先住所 : Texas Instruments, Post Office Box 655303, Dallas, Texas 75265  
Copyright © 2024, Texas Instruments Incorporated