

## ***Serial Interface Dual 8-Channel Relay, LED, Stepper Driver***

---

### **Tests performed:**

#### **1. Basic outputs ON/OFF control and states read back**

Fig 1, Send 0x55 (#1) and 0xAA (#2) to two DRV8860s in daisy chain connection.

Fig 2, Read back outputs states of device #1 and #2.

Fig 3, Example of read back OCP fault (Set outputs ON first).

#### **2. Relay driving example with energizing time and PWM control**

Fig 4, Send output data to turn on OUT4 of #1 with a 12V relay connected.

Fig 5, Send control register for 30ms energizing time followed by 75% duty PWM at all outputs.

Fig 6, Shows the OUT4 output with 30ms energizing and 75% PWM. (Control register: 0xE6)

Fig 7, Zoom in on the PWM duty of Fig 6.

Fig 8, OUT4 output with 30ms energizing time followed by 50% PWM duty. (Control register: 0xC6)

Fig 9, Delay between the rising edge of LATCH and outputs updated.

Fig 10, Delay between ENABLE and outputs ON.

#### **3. PWM output duty test**

Fig 11, Output voltage – set to 12.5% PWM duty (12.5kHz).

Fig 12, Output voltage – set to 25% PWM duty (25kHz).

Fig 13, Output voltage – set to 37.5% PWM duty (50kHz).

Fig 14, Output voltage – set to 50% PWM duty (50kHz).

Fig 15, Output voltage – set to 62.5% PWM duty (50kHz).

Fig 16, Output voltage – set to 75% PWM duty (50kHz).

Fig 17, Output voltage – set to 87.5% PWM duty (50kHz).

#### **4. Unipolar stepper driving pattern test**

Fig 18, Full step commutation output pattern without motor connected.

Fig 19, Half step commutation output pattern without motor connected.

Fig 20, Full step commutation output pattern with stepper connected

Fig 21, Half step commutation output pattern with stepper connected

## Section 1: Basic outputs ON/OFF control and states read back



(Yellow: LATCH; Blue: CLK; Purple: DIN)

Fig 1, Send 0x55 (#1) and 0xAA (#2) to two DRV8860s in daisy chain connection.

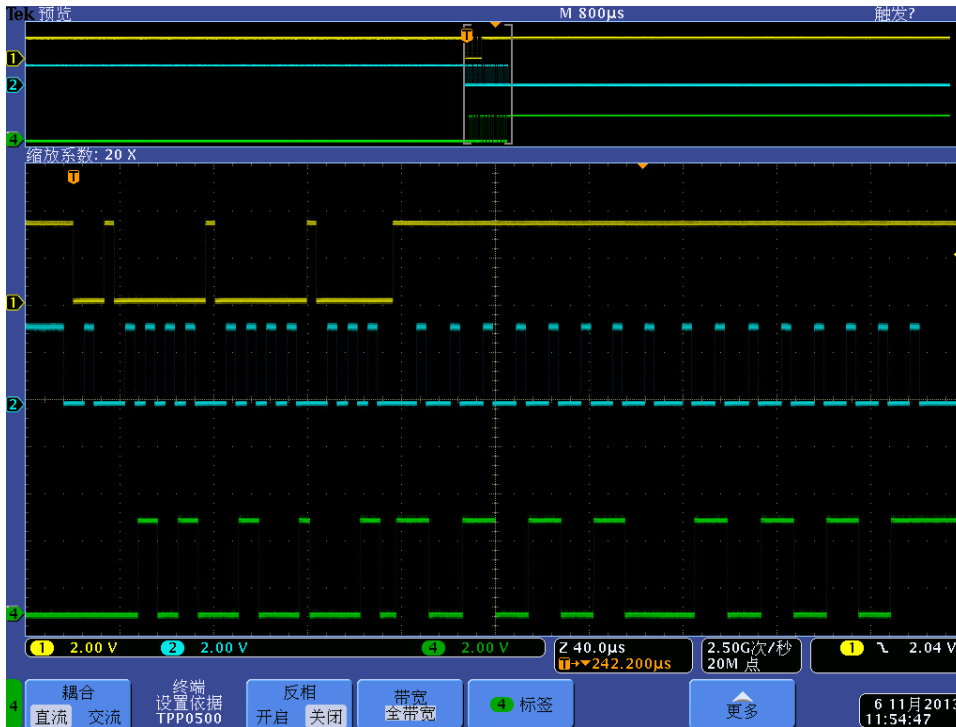

(Yellow: LATCH; Blue: CLK; Green: DOUT2)

Fig 2, Read back outputs states of device #1 and #2.

OUT3 of #2 is short to VM on purpose. Sent output data to turning on OUT3 of #2 first. Then, OCP tripped at OUT3 #2. F11 (OUT3 OCP) of #2 is set to "1". The fault data is clocked out at the falling edge of CLK signal.

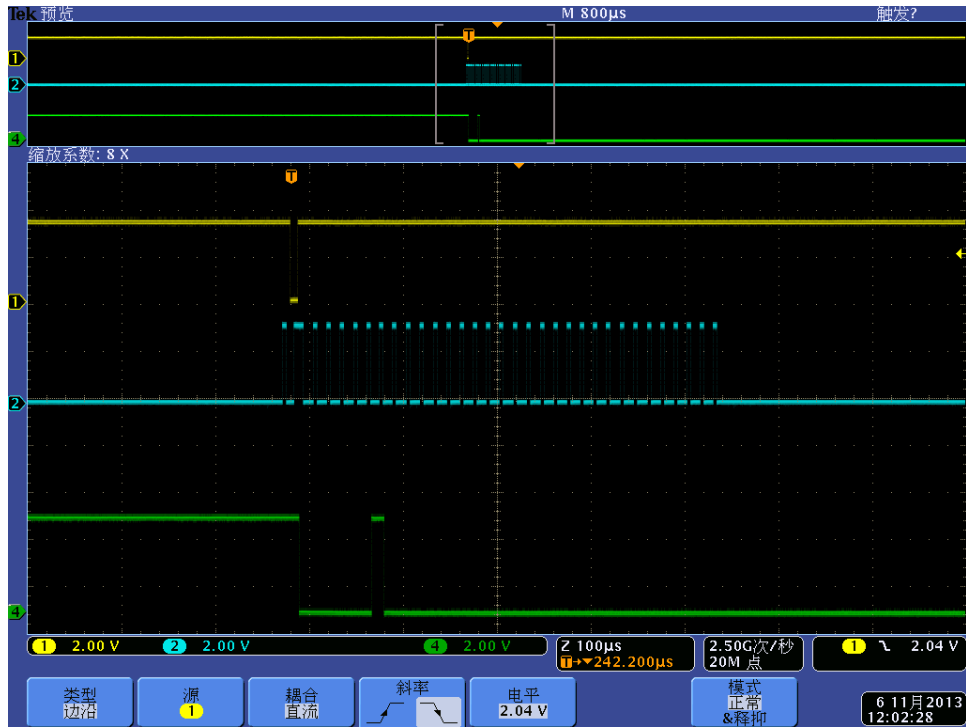

(Yellow: LATCH; Blue: CLK; Green: DOUT2)  
Fig 3, Example of read back OCP fault (Set outputs ON first).

## Section 2: Relay driving example with energizing time and PWM control

VM = 12V. A 12V relay is connected between OUT4 of #1 and VM.



(Yellow: LATCH; Blue: CLK; Purple: DIN; Green: OUT4 of #1)

Fig 4, Send output data to turn on OUT4 of #1 with a 12V relay connected



(Yellow: LATCH; Blue: CLK; Purple: DIN)

Fig 5, Send control register for 30ms energizing time followed by 75% duty



(Yellow: LATCH; Blue: CLK; Purple: DIN; Green: OUT4 of #1)

Fig 6, Shows the OUT4 output with 30ms energizing and 75% PWM. (Control register: 0xE6)

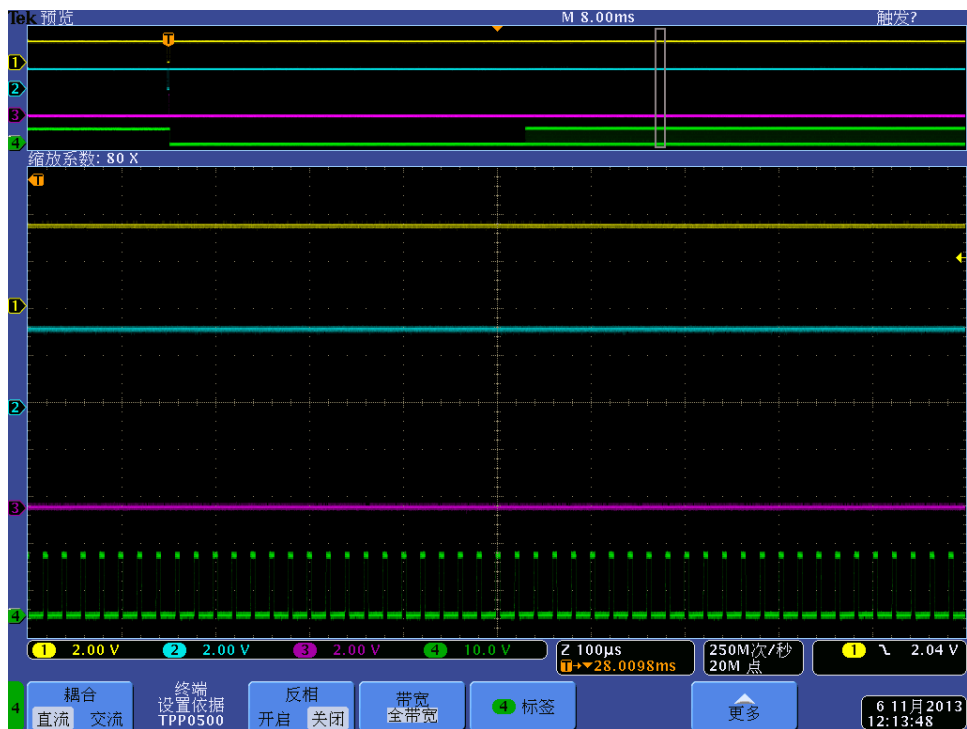

(Yellow: LATCH; Blue: CLK; Purple: DIN; Green: OUT4 of #1)

Fig 7, Zoom in on the PWM duty of Fig 6



(Yellow: LATCH; Blue: CLK; Purple: DIN; Green: OUT4 of #1)

Fig 8, OUT4 output with 30ms energizing time followed by 50% PWM duty. (Control register: 0xC6)

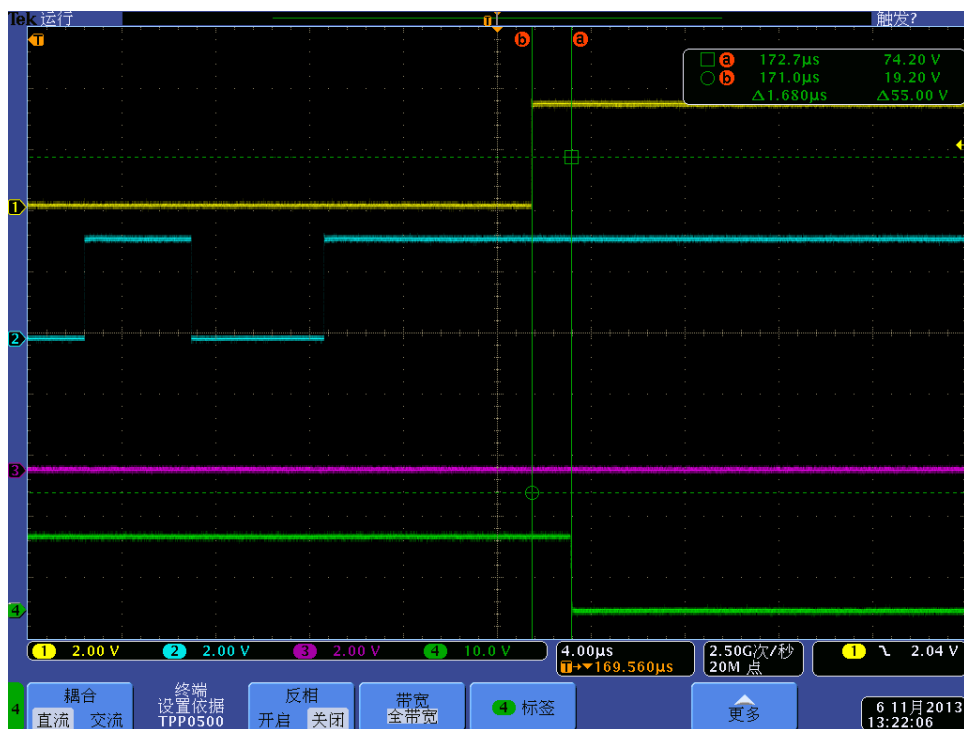

(Yellow: LATCH; Blue: CLK; Purple: DIN; Green: OUT4 of #1)

Fig 9, Delay between the rising edge of LATCH and outputs updated

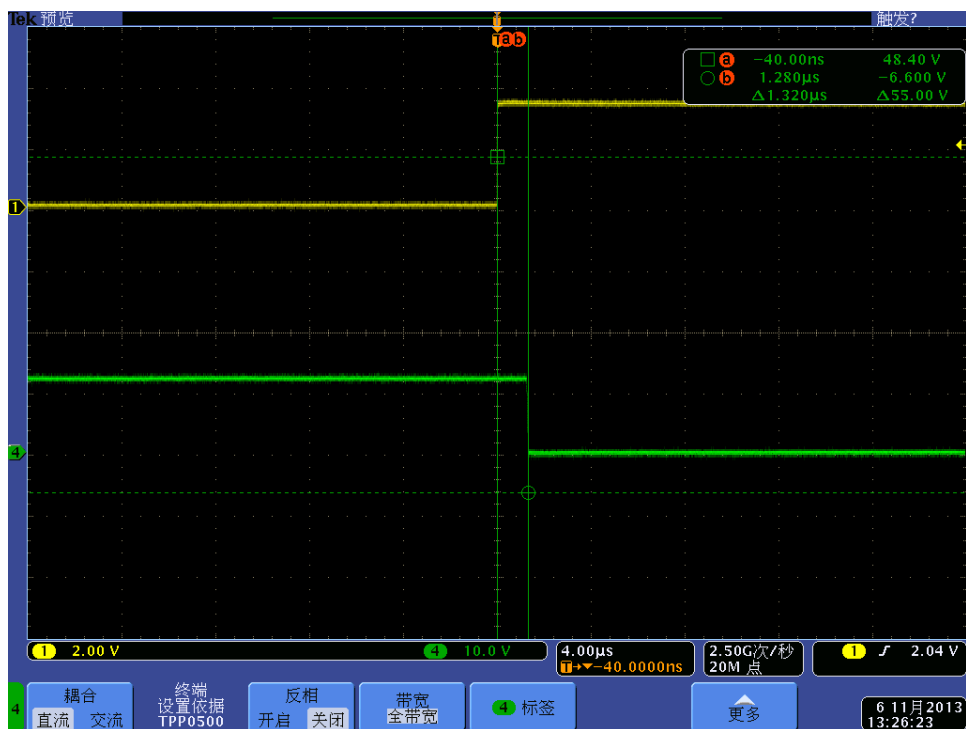

(Yellow: ENABLE; Green: OUT4 of #1)

Fig 10, Delay between ENABLE and outputs ON

### Section 3: PWM output duty test

VM = 15V; On board LED load

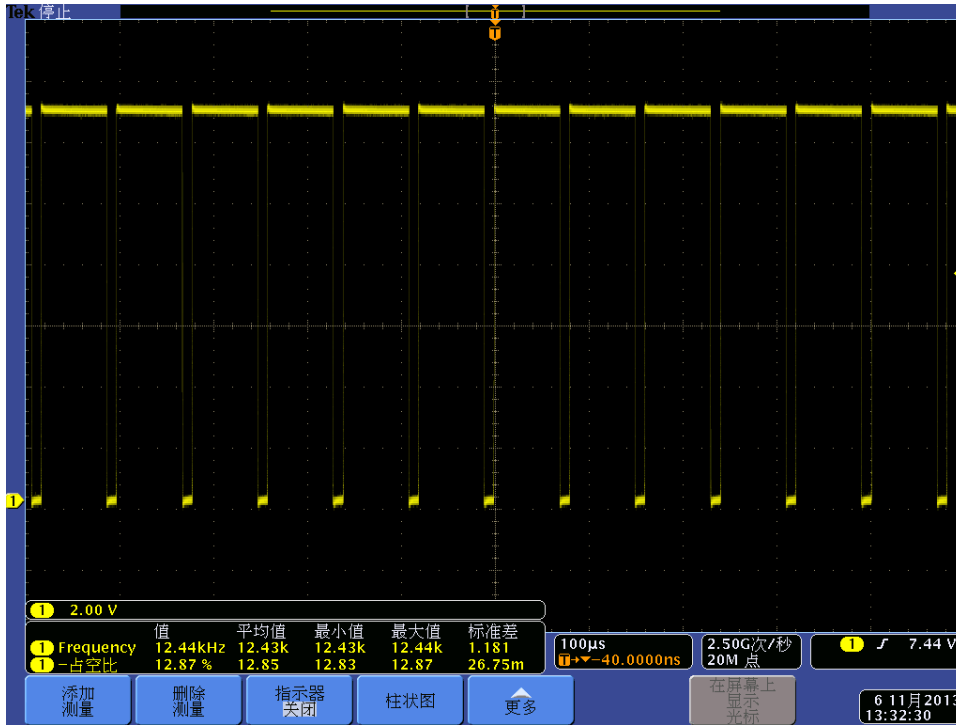

Fig 11, Output voltage – set to 12.5% PWM duty (12.5kHz)

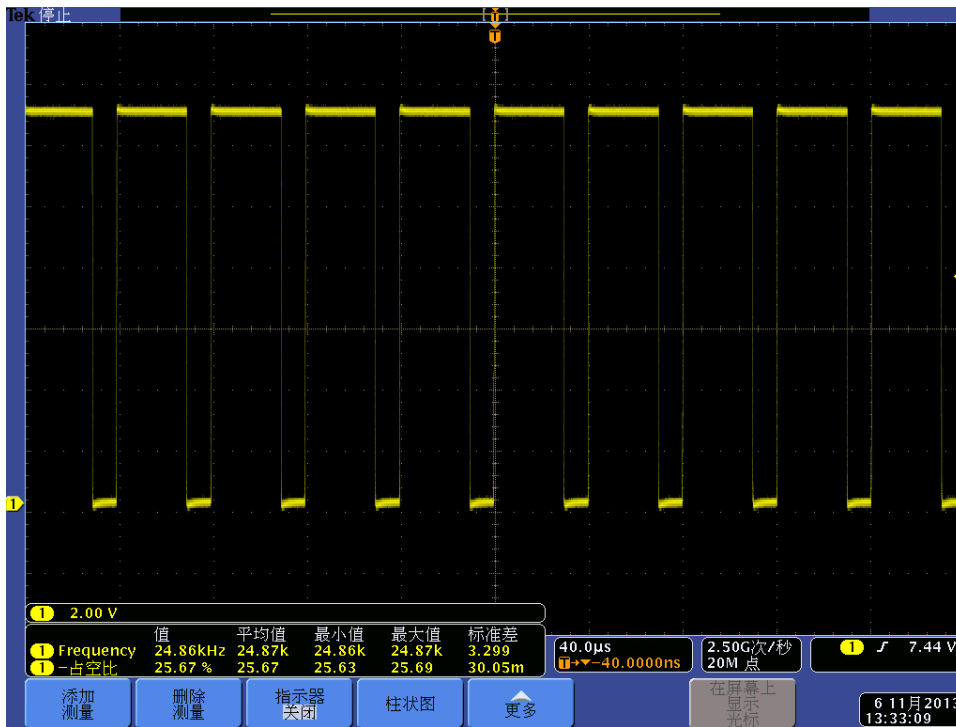

Fig 12, Output voltage – set to 25% PWM duty (25kHz)



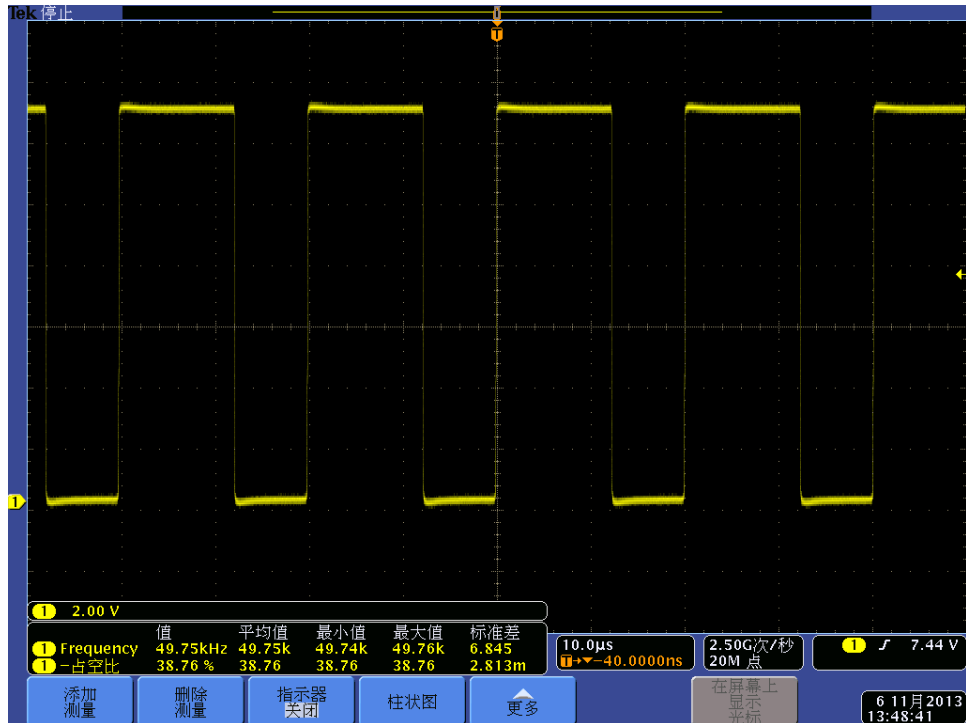

Fig 13, Output voltage – set to 37.5% PWM duty (50kHz)

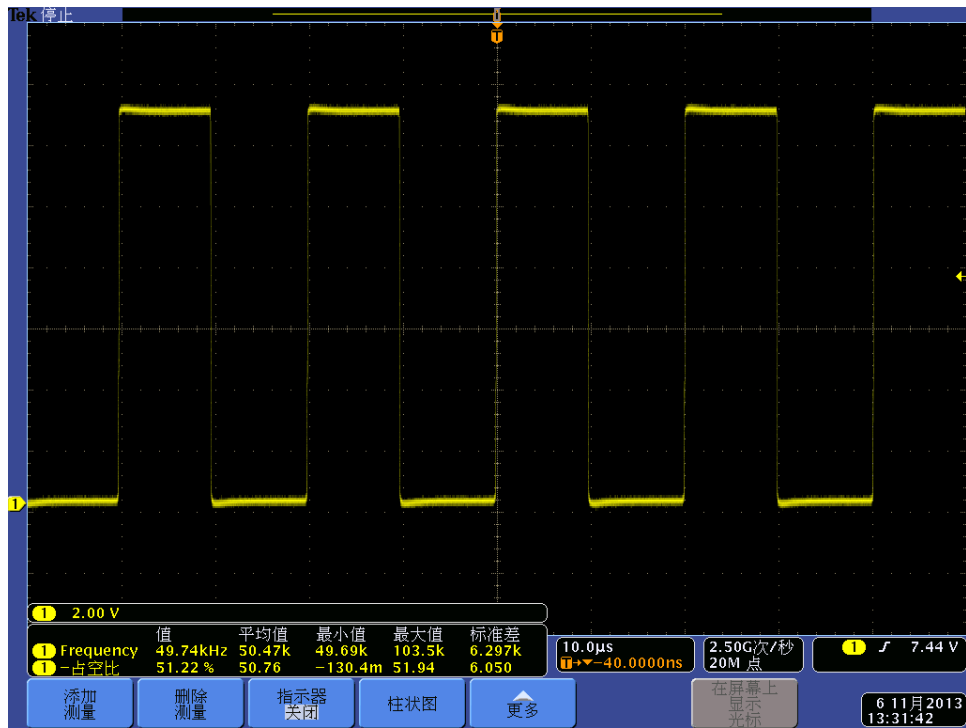

Fig 14, Output voltage – set to 50% PWM duty (50kHz)

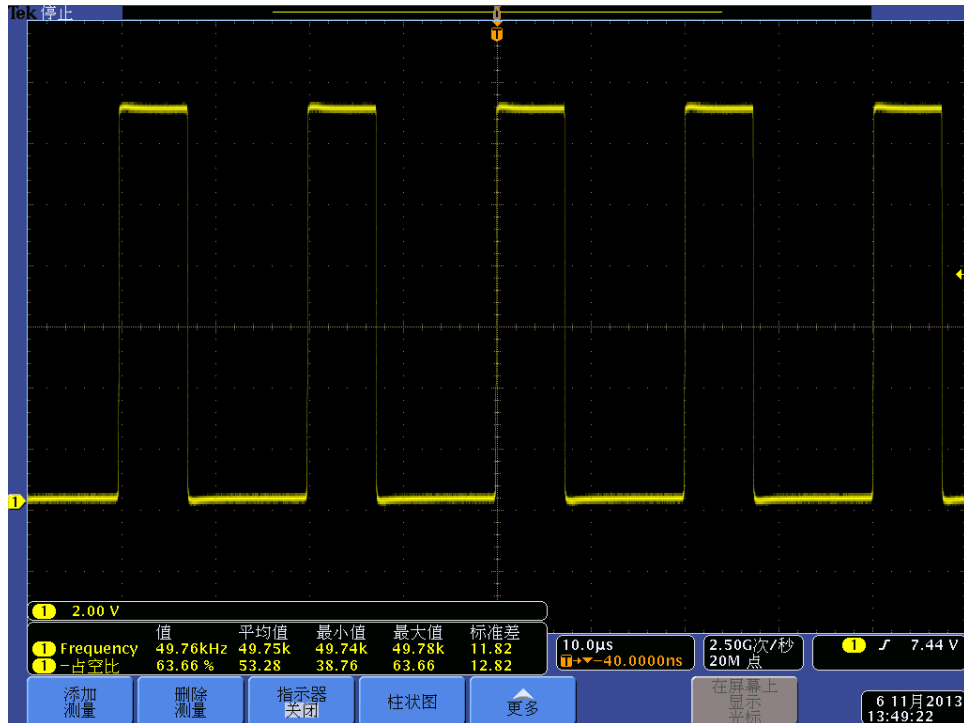

Fig 15, Output voltage – set to 62.5% PWM duty (50kHz)

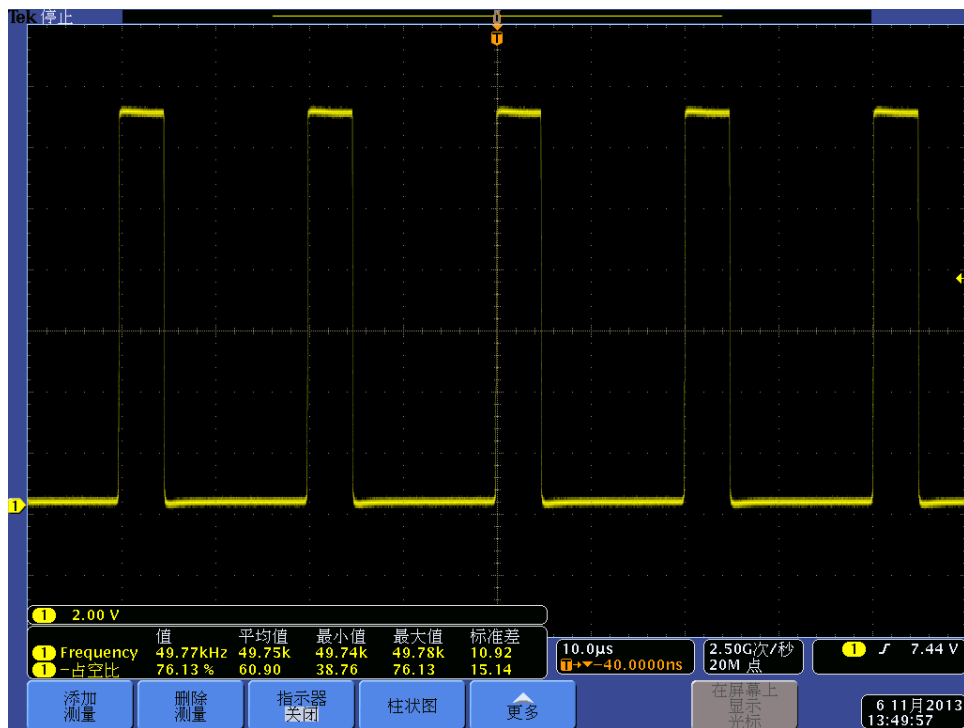

Fig 16, Output voltage – set to 75% PWM duty (50kHz)

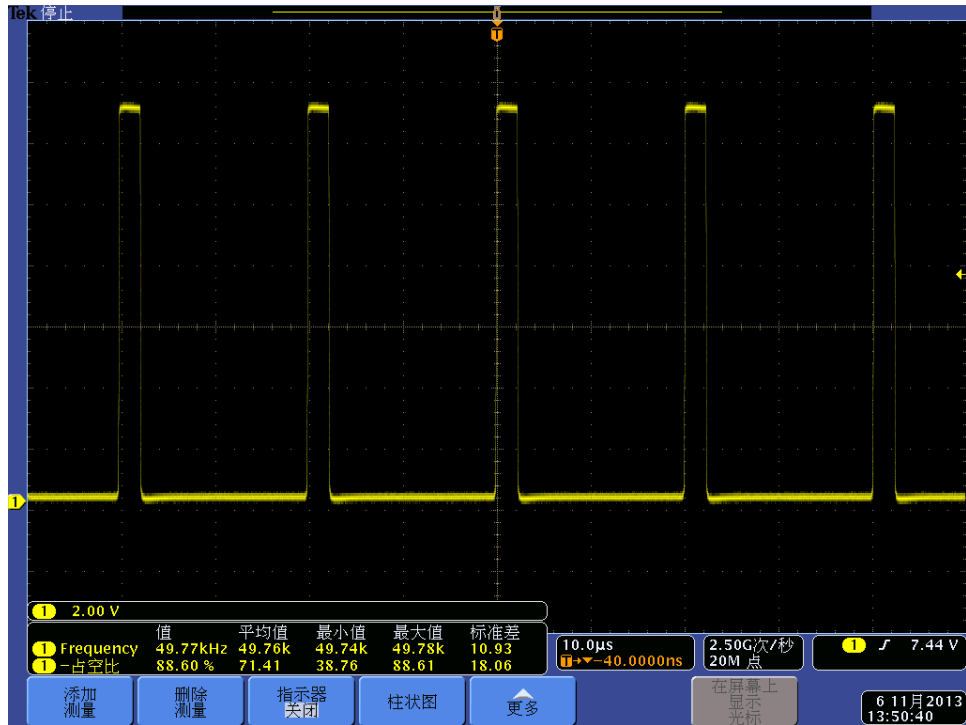

Fig 17, Output voltage – set to 87.5% PWM duty (50kHz)

## Section 4: Unipolar stepper driving pattern test

VM = 12V; LED loads, no unipolar stepper connected.



(Yellow: OUT1 #1; Blue: OUT2 #1; Purple: OUT3 #1; Green: OUT4 of #1)  
Fig 18, Full step commutation output pattern without motor connected



(Yellow: OUT1 #1; Blue: OUT2 #1; Purple: OUT3 #1; Green: OUT4 of #1)  
Fig 19, Half step commutation output pattern without motor connected

Fig 20 and Fig 21 show the output voltage pattern with a unipolar stepper connected as following picture. VM = 12V; Phase resistor (OUTx to VM): 75 ohm; Phase inductance (OUTx to VM): 42mH@1kHz.

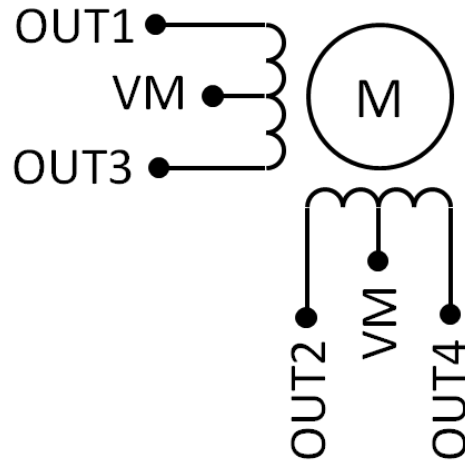

(Yellow: OUT1 #1; Blue: OUT2 #1; Purple: OUT3 #1; Green: OUT4 of #1)  
Fig 20, Full step commutation output pattern with stepper connected



(Yellow: OUT1 #1; Blue: OUT2 #1; Purple: OUT3 #1; Green: OUT4 of #1)  
 Fig 21, Half step commutation output pattern with stepper connected

## IMPORTANT NOTICE FOR TI REFERENCE DESIGNS

Texas Instruments Incorporated ("TI") reference designs are solely intended to assist designers ("Buyers") who are developing systems that incorporate TI semiconductor products (also referred to herein as "components"). Buyer understands and agrees that Buyer remains responsible for using its independent analysis, evaluation and judgment in designing Buyer's systems and products.

TI reference designs have been created using standard laboratory conditions and engineering practices. **TI has not conducted any testing other than that specifically described in the published documentation for a particular reference design.** TI may make corrections, enhancements, improvements and other changes to its reference designs.

Buyers are authorized to use TI reference designs with the TI component(s) identified in each particular reference design and to modify the reference design in the development of their end products. HOWEVER, NO OTHER LICENSE, EXPRESS OR IMPLIED, BY ESTOPPEL OR OTHERWISE TO ANY OTHER TI INTELLECTUAL PROPERTY RIGHT, AND NO LICENSE TO ANY THIRD PARTY TECHNOLOGY OR INTELLECTUAL PROPERTY RIGHT, IS GRANTED HEREIN, including but not limited to any patent right, copyright, mask work right, or other intellectual property right relating to any combination, machine, or process in which TI components or services are used. Information published by TI regarding third-party products or services does not constitute a license to use such products or services, or a warranty or endorsement thereof. Use of such information may require a license from a third party under the patents or other intellectual property of the third party, or a license from TI under the patents or other intellectual property of TI.

TI REFERENCE DESIGNS ARE PROVIDED "AS IS". TI MAKES NO WARRANTIES OR REPRESENTATIONS WITH REGARD TO THE REFERENCE DESIGNS OR USE OF THE REFERENCE DESIGNS, EXPRESS, IMPLIED OR STATUTORY, INCLUDING ACCURACY OR COMPLETENESS. TI DISCLAIMS ANY WARRANTY OF TITLE AND ANY IMPLIED WARRANTIES OF MERCHANTABILITY, FITNESS FOR A PARTICULAR PURPOSE, QUIET ENJOYMENT, QUIET POSSESSION, AND NON-INFRINGEMENT OF ANY THIRD PARTY INTELLECTUAL PROPERTY RIGHTS WITH REGARD TO TI REFERENCE DESIGNS OR USE THEREOF. TI SHALL NOT BE LIABLE FOR AND SHALL NOT DEFEND OR INDEMNIFY BUYERS AGAINST ANY THIRD PARTY INFRINGEMENT CLAIM THAT RELATES TO OR IS BASED ON A COMBINATION OF COMPONENTS PROVIDED IN A TI REFERENCE DESIGN. IN NO EVENT SHALL TI BE LIABLE FOR ANY ACTUAL, SPECIAL, INCIDENTAL, CONSEQUENTIAL OR INDIRECT DAMAGES, HOWEVER CAUSED, ON ANY THEORY OF LIABILITY AND WHETHER OR NOT TI HAS BEEN ADVISED OF THE POSSIBILITY OF SUCH DAMAGES, ARISING IN ANY WAY OUT OF TI REFERENCE DESIGNS OR BUYER'S USE OF TI REFERENCE DESIGNS.

TI reserves the right to make corrections, enhancements, improvements and other changes to its semiconductor products and services per JESD46, latest issue, and to discontinue any product or service per JESD48, latest issue. Buyers should obtain the latest relevant information before placing orders and should verify that such information is current and complete. All semiconductor products are sold subject to TI's terms and conditions of sale supplied at the time of order acknowledgment.

TI warrants performance of its components to the specifications applicable at the time of sale, in accordance with the warranty in TI's terms and conditions of sale of semiconductor products. Testing and other quality control techniques for TI components are used to the extent TI deems necessary to support this warranty. Except where mandated by applicable law, testing of all parameters of each component is not necessarily performed.

TI assumes no liability for applications assistance or the design of Buyers' products. Buyers are responsible for their products and applications using TI components. To minimize the risks associated with Buyers' products and applications, Buyers should provide adequate design and operating safeguards.

Reproduction of significant portions of TI information in TI data books, data sheets or reference designs is permissible only if reproduction is without alteration and is accompanied by all associated warranties, conditions, limitations, and notices. TI is not responsible or liable for such altered documentation. Information of third parties may be subject to additional restrictions.

Buyer acknowledges and agrees that it is solely responsible for compliance with all legal, regulatory and safety-related requirements concerning its products, and any use of TI components in its applications, notwithstanding any applications-related information or support that may be provided by TI. Buyer represents and agrees that it has all the necessary expertise to create and implement safeguards that anticipate dangerous failures, monitor failures and their consequences, lessen the likelihood of dangerous failures and take appropriate remedial actions. Buyer will fully indemnify TI and its representatives against any damages arising out of the use of any TI components in Buyer's safety-critical applications.

In some cases, TI components may be promoted specifically to facilitate safety-related applications. With such components, TI's goal is to help enable customers to design and create their own end-product solutions that meet applicable functional safety standards and requirements. Nonetheless, such components are subject to these terms.

No TI components are authorized for use in FDA Class III (or similar life-critical medical equipment) unless authorized officers of the parties have executed an agreement specifically governing such use.

Only those TI components that TI has specifically designated as military grade or "enhanced plastic" are designed and intended for use in military/aerospace applications or environments. Buyer acknowledges and agrees that any military or aerospace use of TI components that have **not** been so designated is solely at Buyer's risk, and Buyer is solely responsible for compliance with all legal and regulatory requirements in connection with such use.

TI has specifically designated certain components as meeting ISO/TS16949 requirements, mainly for automotive use. In any case of use of non-designated products, TI will not be responsible for any failure to meet ISO/TS16949.